

pure¹¹-Nr.: 1105210, Marke:

Eigenschaften



Empfohlene Reinraumklassen

ISO

GMP

Material

-

Verpackung

- Box

Produktvarianten

pure¹¹-Nr.: 1105210,

pure¹¹-Nr.: 1105210BL10, Halyard Nitril-Handschuhe PUREZERO HG3 blau #CLN923210

Farbe: Blau; Größe: 10 / VE: 300PAAR

pure¹¹-Nr.: 1105210BL6, Halyard Nitril-Handschuhe PUREZERO HG3 blau #CLN923260

Farbe: Blau; Größe: 6 / VE: 300PAAR

pure¹¹-Nr.: 1105210BL6_5, Halyard Nitril-Handschuhe PUREZERO HG3 blau #CLN923265

Farbe: Blau; Größe: 6,5 / VE: 300PAAR

pure¹¹-Nr.: 1105210BL7, Halyard Nitril-Handschuhe PUREZERO HG3 blau #CLN923270

Farbe: Blau; Größe: 7 / VE: 300PAAR

pure¹¹-Nr.: 1105210BL7_5, Halyard Nitril-Handschuhe PUREZERO HG3 blau #CLN923275

Farbe: Blau; Größe: 7,5 / VE: 300PAAR

pure¹¹-Nr.: 1105210BL8, Halyard Nitril-Handschuhe PUREZERO HG3 blau #CLN923280

Farbe: Blau; Größe: 8 / VE: 300PAAR

pure¹¹-Nr.: 1105210BL8_5, Halyard Nitril-Handschuhe PUREZERO HG3 blau #CLN923285

Farbe: Blau; Größe: 8,5 / VE: 300PAAR

pure¹¹-Nr.: 1105210BL9, Halyard Nitril-Handschuhe PUREZERO HG3 blau #CLN923290

Farbe: Blau; Größe: 9 / VE: 300PAAR

GUIDE TO DONNING AND DOFFING OF STERILE CLEANROOM GLOVES

DONNING GLOVES

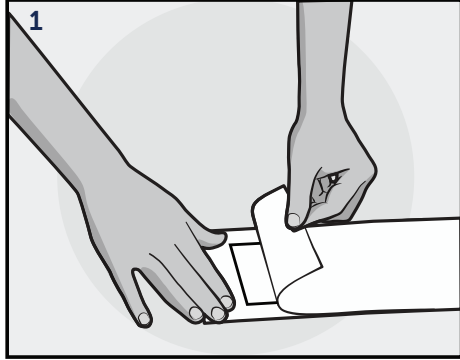

1 Peel open the pouch which keeps the product sterile. Open clear wallet.

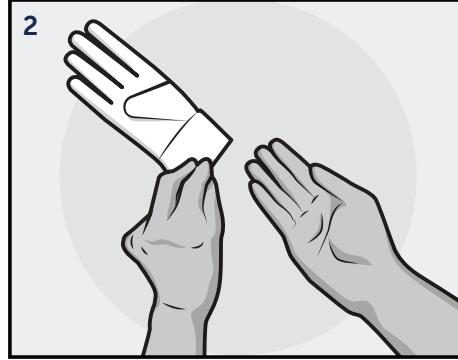

2 Grasp the interior of one glove and carefully pull over the opposite hand.



3 Gently ease the glove up over the hand and wrist, leaving the cuff folded.

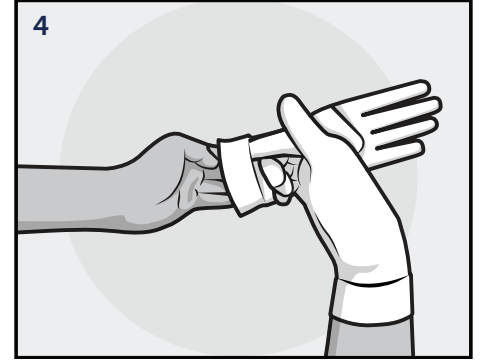

4 Lift the second glove under the folded cuff using gloved fingers.

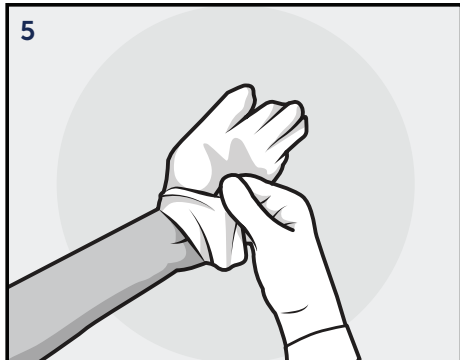

5 Slide your second hand into the glove by holding it under the glove by holding it under the folded cuff, then unfold the cuff over the wrist and arm.

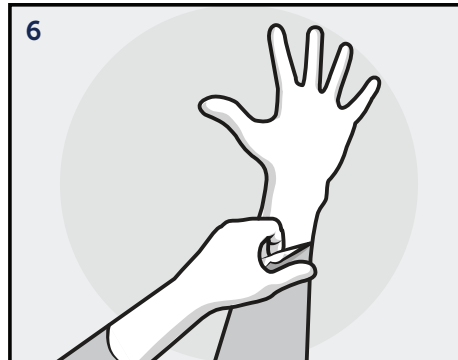

6 Using gloved fingers, unfold the second cuff over your wrist and arm.

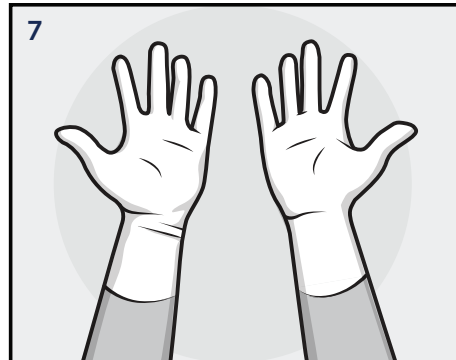

7 To remain sterile, do not touch anything with your gloved hands.

DOFFING GLOVES

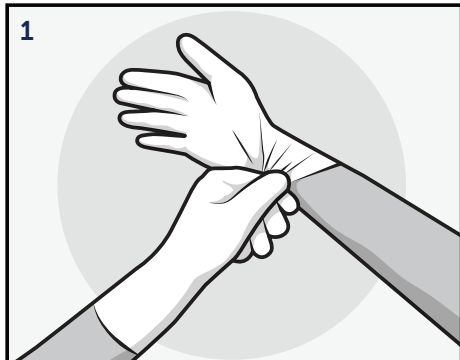

1 Grasp the exterior of one glove with your other gloved hand.

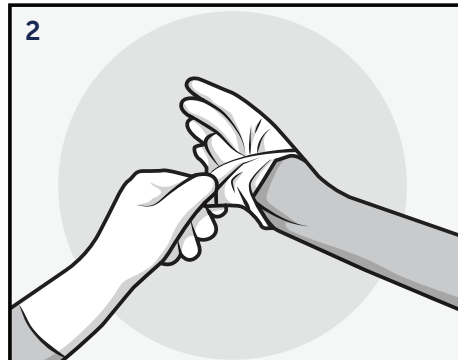

2 Carefully pull the glove off your hand, turning it inside-out.

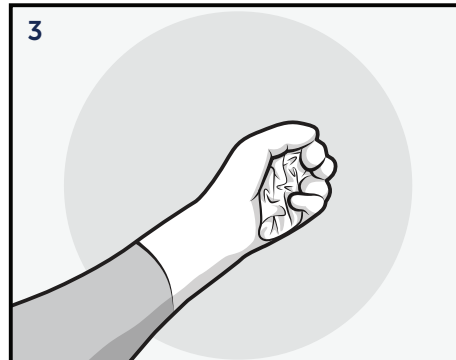

3 Ball the glove up and hold in your other gloved hand.



4 Slide your ungloved fingers into the opening of the other glove.

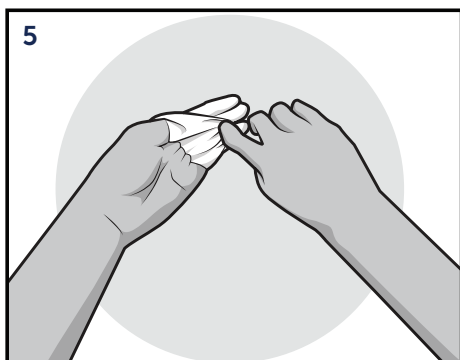

5 Carefully pull the glove off your hand, turning it inside-out and wrapping it around the doffed glove in your palm.

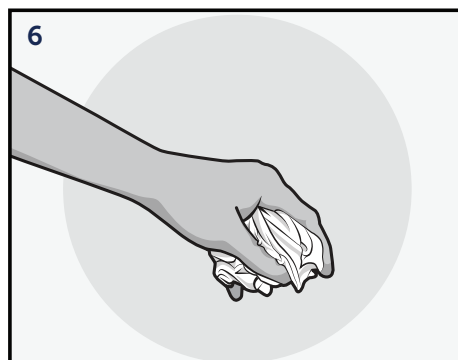

6 Discard appropriately.

HALYARD* recommends double donning/gloving. Don the gloves so that the sleeve cuffs are between the two pairs of gloves.

For more information, contact your HALYARD* representative or distributor, or visit www.purezerogloves.com



HALYARD* **PUREZERO*** HG3 LIGHT BLUE STERILE CLEANROOM GLOVES

DATA PACK



For the Cleanroom Environment
For Industrial Use Only

HALYARD* **PUREZERO*** HG3 LIGHT BLUE STERILE CLEANROOM GLOVES DATA PACK

Some documents depicted here are FOR EXAMPLE ONLY. For specific documents related to lot numbers, please visit www.halyardhealth.com/information, or ask your Distributor or HALYARD* Representative.

TABLE OF CONTENTS

Technical Data Sheet	3
COA – Certificate of Analysis	6
COP - Certificate of Processing	7
Package Labels	9
Case Label	10
Pouch Label	11
Sterilization/Irradiation Label	12
Packaging Certificates	13
Pouch COA	14
Wallet COA	17
Dose Mapping Report	22
Safety Data Sheet	33
REACH Regulation Letter	39
Certificate of Registration 9001: 2015	40
Certificate of Registration ISO 13485: 2016	42
Certificate of Registration ISO 14001:2015	44
Accelerator-Free Letter	45
Chemotherapy Drug Resistance Guide	46
Chemical Resistance Guide	47
ESD Testing letter	48
BSE/TSE Letter	52
Storage Conditions Letter	53
Silicone-Free Letter	54
Packaging Supplier Notification Letter	56

TECHNICAL DATA SHEET



TECHNICAL DATA SHEET

 Meets
 USP <797>
 Guidelines.

 Meets
 USP <800>
 Guidelines.

Description

HALYARD* **PUREZERO*** HG3 Light Blue Sterile Nitrile Cleanroom Gloves are designed for critical cleanroom environments such as pharmaceutical and biotechnology cleanroom manufacturing as well as sterile compounding cleanroom applications. These hand specific gloves are clean processed (washed repeatedly in deionized water) to ensure consistent control of low particles, extractables and endotoxin levels, and are recommended for use in ISO Class 3 or higher and Grade A/B cleanrooms. Because HALYARD* **PUREZERO*** HG3 Sterile Cleanroom Gloves are made with an **accelerator-free**¹ nitrile polymer, there is a reduced risk of allergies and skin irritation associated with accelerator chemicals in other nitrile gloves.



Manufactured at OUR OWN
 Safeskin Facility in Thailand.

Cleanliness Properties

Max Particle Count (>0.5 µm)	<1200 Particles/cm ²	IEST RP-CC005
Max Endotoxin Level	<20 EU	
Ionic Content (Extractable ions)	Max Level (ug/g)	IEST RP-CC005
Calcium	50	
Chloride	35	
Magnesium	5	
Nitrate	20	
Potassium	5	
Sodium	10	
Sulfate	10	
Zinc	7	
Ammonium	5	

Physical Properties

AQL	0.65
Sterile	✓
Hand Specific Pairs	✓
Smooth Grip	✓
Textured Fingertips and Palms	✓
Accelerator-Free ¹	✓
Latex-Free	✓
Powder-Free	✓
Silicone-Free	✓
Contains No Nickel	✓
Static Dissipative in Use	✓
Tensile Strength ²	35 MPa (Target)
Ultimate Elongation ²	600%
Sterility Assurance Level (SAL)	10 ⁻⁶
Shelf Life	3 Years

TECHNICAL DATA SHEET

Glove Dimensions

	6.0	6.5	7.0	7.5	8.0	8.5	9.0	10.0
Glove Length (inch/cm)	12"/30.5	12"/30.5	12"/30.5	12"/30.5	12"/30.5	12"/30.5	12"/30.5	12"/30.5
Width of Palm (mm)	80	87	94	98	109	114	120	128
Middle finger length (mm)	73.2	76.9	81.2	85.3	87.3	91.7	93.7	97.8
Finger Tip Thickness	0.10 mm (3.9 mil)	0.10 mm (3.9 mil)	0.10 mm (3.9 mil)	0.10 mm (3.9 mil)	0.10 mm (3.9 mil)	0.10 mm (3.9 mil)	0.10 mm (3.9 mil)	0.10 mm (3.9 mil)
Palm Thickness	0.08 mm (3.1 mil)	0.08 mm (3.1 mil)	0.08 mm (3.1 mil)	0.08 mm (3.1 mil)	0.08 mm (3.1 mil)	0.08 mm (3.1 mil)	0.08 mm (3.1 mil)	0.08 mm (3.1 mil)
Cuff Thickness	0.07 mm (2.75 mil)	0.07 mm (2.75 mil)	0.07 mm (2.75 mil)	0.07 mm (2.75 mil)	0.07 mm (2.75 mil)	0.07 mm (2.75 mil)	0.07 mm (2.75 mil)	0.07 mm (2.75 mil)

Packaging Data

Triple layer packaging (poly pouch and poly bag plus case liner)

300 pairs per case: one glove pair/ poly wallet & pouch X 30 sealed pouches per PE bag x 10 PE bags per lined carton

Packaged in ISO Class 5 Cleanroom

The PUREZERO* HG3 Sterile Nitrile Cleanroom glove sterile pouch is made from PET/PE film pouch and is Plastic Recycling Number/ Category 7.

Quality & Regulatory Standards

Compliant to these regulatory standards:

ISO 9001
 ISO 13485
 ISO 14001

Compliant to these food handling regulatory standards:

FDA 21 CFR 177-2600
 FDA 21 CFR 180.22
 Commission Regulation (EU) No 10/2011

CE 2797 PPE Category III according to Regulation (EU) 2016/425 EEC
 EN 16523-1:2015+A1:2018

EN ISO 374-2:2019
 EN ISO 374-4:2019
 EN ISO 374-5:2016 Bacteria, Fungi, and Virus Protection
 EN ISO 374-1:2016+A1:2018/ Type B

EN ISO 21420:2020 Dexterity Classification: Level 5

Compliant with the REACH regulation

RoHS 2011/65/EU Annex II
 Static Dissipative in Use
 Tested per ANSI/ ESD SP 15.1

Meets USP <800> Guidelines
 Meets USP <797> Guidelines

Additional Glove Information

Recommended for use in ISO Class 3 or higher and Grade A/B cleanrooms.

Tested against 29 chemicals, 14 chemotherapy drugs and Fentanyl.

Made in Thailand

Declaration of Conformity (DoC), Certificates of Analysis (COA) and Certificates of Processing (COP) for every production lot available online at halyardhealth.com/information

Storage Instructions

HALYARD* PUREZERO* Nitrile Gloves shall be stored in conditions where the product is kept dry (away from moisture), away from direct sunlight, away from sources of heat, and away from radioactive sources.

Ordering Information

HALYARD* PUREZERO* HG3 LIGHT BLUE STERILE NITRILE GLOVES, HAND SPECIFIC, SMOOTH GRIP, TEXTURED FINGERTIPS AND PALMS

Size	Code	Size	Code
6.0	CLN923260	8.0	CLN923280
6.5	CLN923265	8.5	CLN923285
7.0	CLN923270	9.0	CLN923290
7.5	CLN923275	10.0	CLN923210

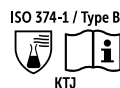

¹ Not formulated with these commonly used vulcanizing chemicals: Sulfur, Thiurams, Thiazoles, Guanidines and Carbamates.

² Tested per ASTM D412

This fact sheet has been created using the most recent information. In the interest of continuous improvement, the characteristics of the products may change without prior notice.

*Registered Trademark or Trademark of O&M Halyard or its affiliates. ©2020, 2021, 2023 2025. All rights reserved. 008641 COPY-04711 May 20235

For additional information or samples,
 contact your local distributor or visit
www.purezerogloves.com



HALYARD* is an Owens & Minor brand



Safeskin Medical & Scientific (Thailand) Ltd. 200 Moo 8 Kanchanavanich Road Tambol Prik, Amphur Sadao Songkhla 90120 Thailand

CERTIFICATE OF ANALYSIS

Product Description : HALYARD* PUREZERO* HG3 Sterile Light Blue Nitrile Gloves - Pairs

Catalog Numbers : CLN923260, CLN923265, CLN923270, CLN923275, CLN923280, CLN923285, CLN923290, CLN923210

OMH Code : 48172-82, 48173-82, 48174-82, 48175-82, 48176-82, 48177-82, 48178-82, 48179-82

Batches : SM506026X to SM509026X

Total Cases per Lot : 1,234

Date of Manufacture : Mar-25

Expiration Date : 2028-02-28

Physical Test Data

	Watertight	Visual Defects		Dimensions	Tensile (MPa)	Elongation (%)	Median Force at Break (N)
		Minor	Negligible		Pre Aging	Pre Aging	Pre Aging
					Sample Size :	860	860
AQL Level :	0.65	2.5	4.0	4.0	4.0	4.0	4.0
Failures Allowed per AQL :	6	32	49	16	7	7	7
Failures :	0	0	0	0	0	0	0
Inspection Results :	Accept	Accept	Accept	Accept	Accept	Accept	Accept
Averages:					37.90	588	9.48

Test Methods : Water tight test ASTM D 5151, EN 455-1, Elongation and Tensile ASTM D 412, ASTM D 6319, Median Force at Break EN 455-2, Dimension ASTM D 6319, EN 455-2

Particle Test Data

Particle #/cm ² :	Total Particles/cm ²	Inspection Result
Particulate Level (≥0.5 microns) #/cm ²	911	Accept

Test Method : IEST-RP-CC005.4

Extractable Ion Test Data

Units :	Anions Results				Cations Results			
	Chloride Cl ⁻	Nitrate NO ₃ ⁻	Sulfate SO ₄ ⁻²	Sodium Na ⁺	Ammonium NH ₄ ⁺	Potassium K ⁺	Magnesium Mg ⁺²	Calcium Ca ⁺²
µg/g glove	28.026	3.927	2.158	2.572	1.710	2.068	1.591	23.162
Inspection Result :	Accept	Accept	Accept	Accept	Accept	Accept	Accept	Accept

Trace Element Results

Units :	Zinc Zn
µg/g glove	6.16
Inspection Result :	Accept

Test Method : IEST-RP-CC005.4

Endotoxin Test Data

Test Result :	BD	Endotoxin Units/ device
Specification :	≤ 20	Endotoxin Units/ device

Detection Limit is ≤ 0.4 EU/device • BD = Below Detection Limit

Test Method : Limulus Amebocyte Lysate (LAL) Test: Kinetic Turbidimetric Technique

Sterility Data

This product conforms to standards for sterility ISO11137 with sterility assurance level (SAL) 10⁻⁶. A Certificate of Irradiation is also available to assure that the product has received the specified radiation dosage.

Review By :

GR
17 Apr 2025
(QA Sr. Manager)

STERIS: Certificate Of Processing

Prepared For SAFESKIN MEDICAL & SCIENTIFIC (THAILAND) LTD (10230)
Gamma Process Run ID 3023-5023A

<u>Product Code</u>	<u>Lot Number</u>	<u>Quantity</u>	<u>UOM</u>
HALYARD* PUREZERO* HG3 STERILE LIGHT BLUE NITRILE GLOVES - PAIRS	N/A	1551	Case

Validation Reference Number: 0.0968 Rev01

Processing Run Start Date 02-Apr-2025 9:50 AM
Processing Run End Date 03-Apr-2025 8:55 AM

Specified Dose Range (kGy)	25.0 - 50.0	Calculated Min Dose (kGy)	28.1
Reference Dose Range (kGy)	27.0 - 45.9	Calculated Max Dose (kGy)	34.9

PO Number: 4027025838

Product meets Customer specifications; zero nonconformities occurred during this irradiation run.

Other Information

Refer Attachment 1

<p><u>Signature Manifest</u></p> <p>Reviewed and E-Signed By: Nursyuhada Shoib (Quality Analyst)</p> <p>DateTime Esigned 03-Apr-2025 5:54 PM</p> <p>Document Content Revision 1</p>

Operating facility is in compliance with applicable regulations providing services under a certified quality system which meets the requirements of FDA QSR, EN/ISO 13485, ISO 9001 current version and is in alignment with EN/ISO 11137 current version.

Processing Location

Synergy Sterilisation (M) Sdn Bhd
Plot 203, Kuala Ketil Industrial Park
09300 Kuala Ketil
Kedah Malaysia
Phone: (60)44152111

Document ID: 81292



Attachment 1

Run ID Process :3023-5023A

HALYARD* PUREZERO* HG3 Sterile Light Blue Nitrile Gloves - Pairs

Catalog Numbers : CLN923260, CLN923265, CLN923270, CLN923275, CLN923280, CLN923285, CLN923290, CLN923210.

OMH Code : 48172-82, 48173-82, 48174-82, 48175-82, 48176-82, 48177-82, 48178-82, 48179-82

Catalog Number(s)	Lot No./Batch No.	Quantity
CLN923260 48172-82	NIL/SM506126X	100
CLN923270 48174-82	NIL/SM506726X	36
CLN923270 48174-82	NIL/SM506626X	50
CLN923270 48174-82	NIL/SM506426X	55
CLN923270 48174-82	NIL/SM506126X	88
CLN923270 48174-82	NIL/SM506026X	145
CLN923270 48174-82	NIL/SM502626X	10
CLN923270 48174-82	NIL/SM502526X	26
CLN923270 48174-82	NIL/SM502426X	31
CLN923275 48175-82	NIL/SM506826X	325
CLN923275 48175-82	NIL/SM506726X	25
CLN923275 48175-82	NIL/SM506026X	20
CLN923275 48175-82	NIL/SM505926X	280
CLN923280 48176-82	NIL/SM506726X	60
CLN923280 48176-82	NIL/SM506126X	36
CLN923280 48176-82	NIL/SM506026X	264

PACKAGE LABELS

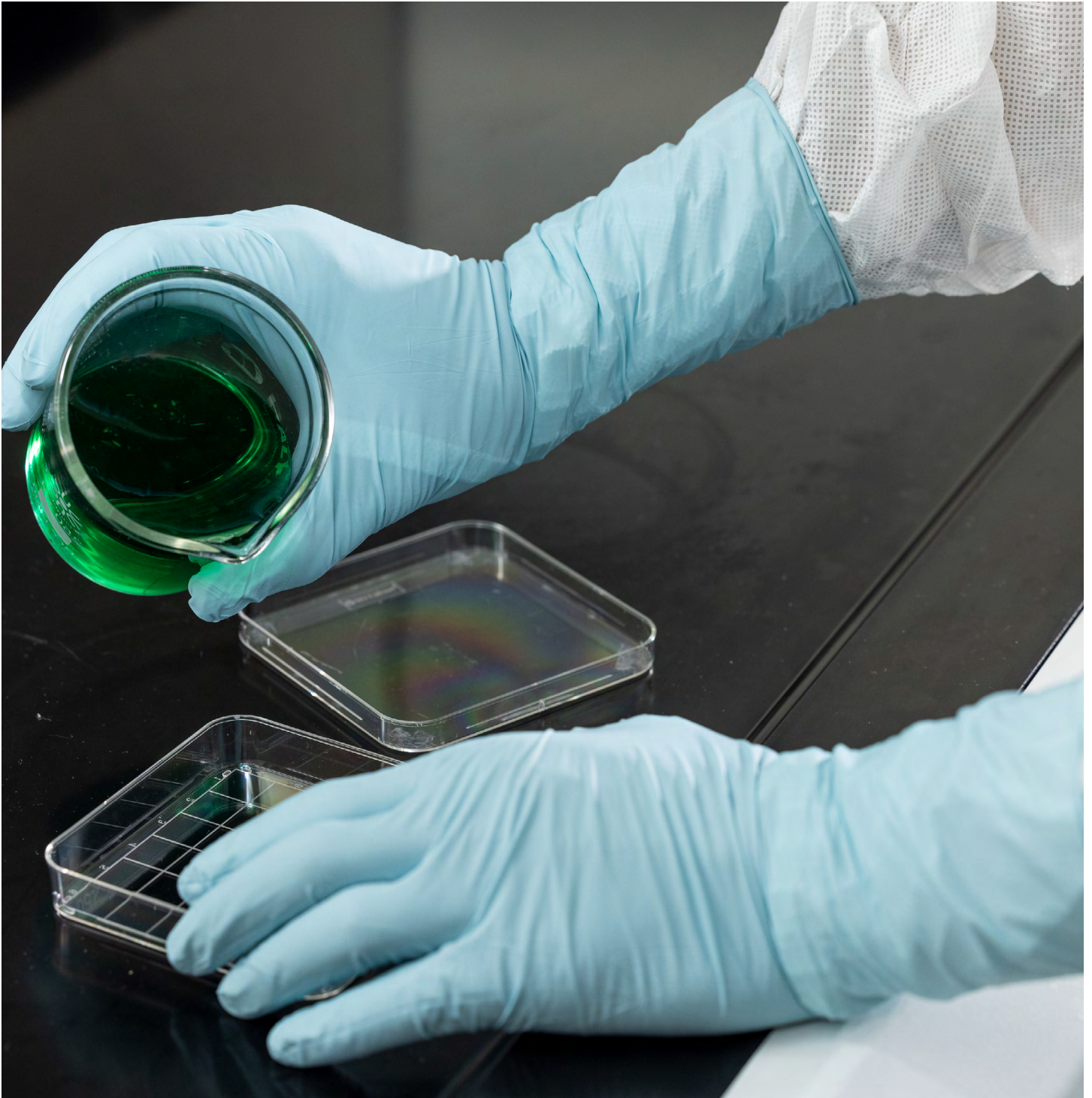

PUREZERO* HG3
STERILE LIGHT BLUE NITRILE GLOVES **7**

- FR Gants stériles en nitrile bleu clair HG3
- DE HG3 Sterile Nitrilhandschuhe, hellblau
- BG Стерилни светлосини нитрилни ръкавици HG3
- ES Guantes de nitrilo estériles celestes HG3
- CS Sterilní světlé modré nitrilové rukavice HG3
- DA HG3 Sterilise lyseblå nitrilhandsker
- ET HG3 steriilsed helesinised nitrilkindad
- EL HG3 Γαλάζια αποστειρωμένα γάντια νιτριλίου
- IT Guanti in nitrile sterili azzurri HG3
- LV HG3 sterili, gaiši zili nitrila cimdi
- LT HG3 sterilios šviesiai mėlynos nitrilinės pirštinės
- HR HG3 sterilne svijetlo plave nitrilne rukavice
- RU HG3 стерильные перчатки голубого цвета



AQL 0.65 Level 3 Cl	ISO 374-5:2016 VIRUS	ISO 374-1 Type B KIT	EN 421:2010
		EN ISO 374-1:2016+A1:2018	

Product of Thailand

104817483 **CLN923270**

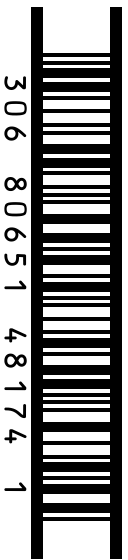

PUREZERO* HG3
STERILE LIGHT BLUE NITRILE GLOVES **7**

- MT HG3 Ingwanti tan-Nitril Blu Ċari Sterili
- NL HG3 Lichtblauwe steriele nitril handschoenen
- NO HG3 sterile lyseblå nitrilhansker
- PL HG3 Sterylne jasnoniebieskie rękawice nitylowe
- PT Luvas de nitrilo azuis-claras HG3 esterilizadas
- RO Mănuși din nitril albastre deschis sterile HG3
- RU Стерильные голубые нитриловые перчатки HG3
- SK Sterilné bledomodré nitrilové rukavice HG3
- BL Sterilne svetlo modre rokavice HG3
- ET Steriilne vaaleansinised nitrilikäsinet
- SU HG3 Sterilia jusbhå nitrilhandskar
- JA ピュアゼロ HG3 ライトブルー滅菌ニトリルグローブ
- KO HG3 하늘색 니트릴 장갑
- ZH HG3 无菌浅蓝色丁腈手套



AQL 0.65 Level 3 Cl	ISO 374-5:2016 VIRUS	ISO 374-1 Type B KIT	EN 421:2010
		EN ISO 374-1:2016+A1:2018	

Product of Thailand

104817483 **CLN923270**

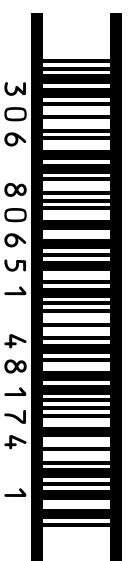

POUCH LABEL



REF

CLN923270

7

LOT





FPO

6 80651 48174 0



PUREZERO* HG3

STERILE LIGHT BLUE NITRILE GLOVES

For the Critical Environment

12 in. / 30.5 cm

Hand Specific

FR Gants stériles en nitrile bleu clair HG3 • Pour les environnements critiques • Pour usage industriel uniquement • Sans accélérateur* • S'adaptent à la main
DE HG3 Sterile Nitrilhandschuhe, hellblau • Für kritische Umgebungen • Nur für den industriellen Gebrauch • Beschleunigerfrei* • Handspezifisch
ES Guantes de nitrilo estériles celestes HG3 • Para entornos críticos • Solo para uso industrial • Sin aceleradores* • Específico para cada mano
IT Guanti in nitrile sterili azzurri HG3 • Per ambiente critico • Solo per uso industriale • Privi di acceleranti* • Destri e sinistri
NL HG3 Lichtblauwe steriele nitril handschoenen • Voor gebruik in kritieke schone ruimtes/cleanrooms • Alleen voor industrieel gebruik • Versnellervrij* • Handspecifiek
PT Luvas de nitrilo azuis-claras HG3 esterilizadas • Para ambientes de salas limpas críticas • Exclusivamente para utilização industrial • Sem aceleradores* • Formato anatômico
RU Стерильные голубые нитриловые перчатки HG3 • Для критических условий • Только для промышленного использования • Без химических присадок* • На правую и левую руки
JA ピュアゼロ HG3ライトブルー滅菌ニトリルグローブ • 無菌クリーンルーム環境対応 • 工業用途のみ • 加硫促進剤不使用* • 左右別
KO HG3 하늘색 니트릴 장갑 • 클린룸 환경용 • 산업용으로만 사용 • 촉진제 없음* • 양손형
ZH 无菌浅蓝色丁腈手套 • 适用于关键环境 • 仅限工业使用 • 无催化剂* • 区分左右手

Manufactured at our SAFESKIN® Facility

ACCELERATOR FREE*								
	STERILE R							AQL 0.65 Level 3 G1
 halyardhealth.com/information				CE 2797 (PPE Cat. III)		UK CA 0086		

* Not formulated with the following vulcanizing chemicals and accelerators: Sulfur, Thiurams, Thiazoles, Guanidines, Carbamates

 O&M Halyard, Inc., 1220 Old Alpharetta Rd., Ste. 320, Alpharetta, GA 30005 • In USA, please call 1-844-425-9273 • halyardhealth.com
 ArcRoyal Unlimited Company, Virginia Road, Kells, Co Meath, Ireland
 O&M Halyard Belgium BV, Berkenlaan 8B, 1831 Machelen (Brab.), Belgium
 Product certified to the Regulation (EU) 2016/425 by Notified Body 2797 BSI Group The Netherlands B.V., Say Building, John M. Keynesplein 9, 1066 EP Amsterdam, and to the Regulation (EU) 2016/425 on personal protective equipment, as amended to apply in Great Britain by Approved Body BSI Assurance UK Ltd (0086) Kitemark Court, Davy Avenue, Milton Keynes, MK5 8PP.
 UK RP • RLD Quality Limited Centenary House, Peninsula Park, Rydon Lane, Exeter, EX2 7XE, United Kingdom
 Sponsored in Australia by O&M Halyard Australia Pty Ltd., Tenancy 1, Level 1, Triniti 3, 39 Delhi Road, North Ryde NSW 2113
 販売元 O&M Halyard Japan合同会社 東京都港区芝公園2-6-3 芝公園フロントタワー12階 Product of Thailand

*Registered Trademark or Trademark of O&M Halyard, Inc., or its affiliates. © 2018. All rights reserved.
 Patent and/or Pending Application. See www.halyardhealth.com/patents. 08-HM-050-0-02

STERILIZATION/IRRADIATION LABEL

Irradiation Label Format – HALYARD* PUREZERO* HG3 Sterile Nitrile Gloves

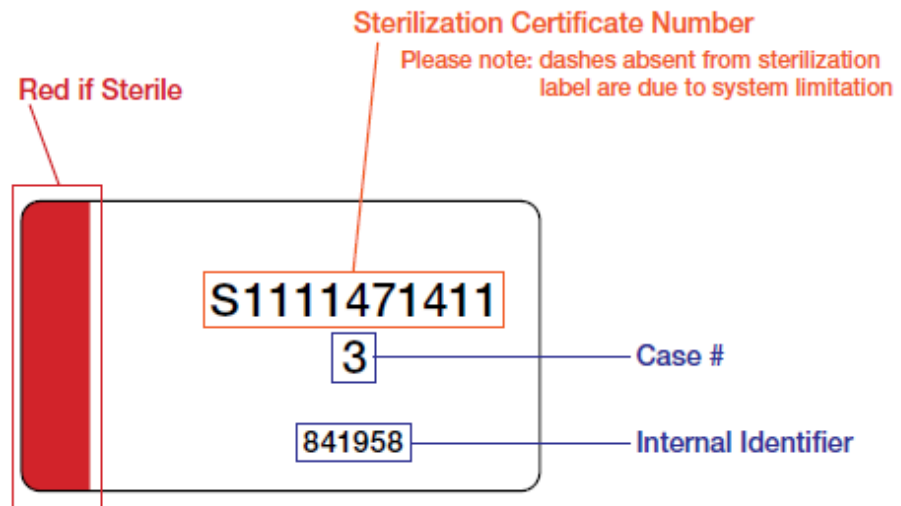

PACKAGING CERTIFICATES



POUCH



TIP CORPORATION SDN BHD

Lot 2288, Jalan P4/8, Bandar Teknologi Kajang,
Semenyih, 43500 Selangor, Malaysia.
Tel: +603-8723 7889
E-mail: sales@tipcorp.com Website: www.tipcorp.com
SST No: W24-1808-21017734



FORM QC-21

LPC Test Report

Item: C/R EASY PEEL-PRT Lot No: K34514(Outgoing A)
Testing Date: 26.10.2020 Size: 152.4 X 304.8 X 0.07MM
Customer: SAFESKIN Method: BY HAND
Machine: BS-5

Blank Particle Counts (Cumulative)

	Blank Cts 1 Counts	Blank Cts 2 Counts	Blank Ct 3 Counts	Average Blank (A) Counts	
0.5 micron	2.0	4.0	3.0	3.0	
1.0 micron	0.0	0.0	0.0	0.0	
2.0 micron	0.0	0.0	0.0	0.0	
5.0 micron	0.0	0.0	0.0	0.0	0.0 Total counts 3.0
					0.0

W Sample Particle Counts (Cumulative)

	Washed Cts 1 Counts	Washed Cts 2 Counts	Washed Cts 3 Counts	Average Washed (B) Counts	
0.5 micron	16.0	13.0	10.0	13.0	
1.0 micron	3.0	4.0	2.0	3.0	
2.0 micron	0.0	1.0	0.0	0.3	
5.0 micron	0.0	0.0	0.0	0.0	0.3 Total counts 16.3
					0.0

(C) Wet Particle Counts

Ave. Washed - Ave. Blank (C = B - A)

0.5 micron	10.0
1.0 micron	3.0
2.0 micron	0.3
5.0 micron	0.0

(D) Total Vol. for Washed Sample

Washed Volume (ml) 400 ml

(E) Sampling size 5 ml

(F) Total Area of Plastic

Total Washed Area 853 cm²

(G) Particle counts per ml (G = C / E)

0.5 micron	2.000
1.0 micron	0.600
2.0 micron	0.067
5.0 micron	0.000

(H) Total Wet Part Cts / cm² (H = G X D / F)

0.5 micron	0.938
1.0 micron	0.281
2.0 micron	0.031
5.0 micron	0.000

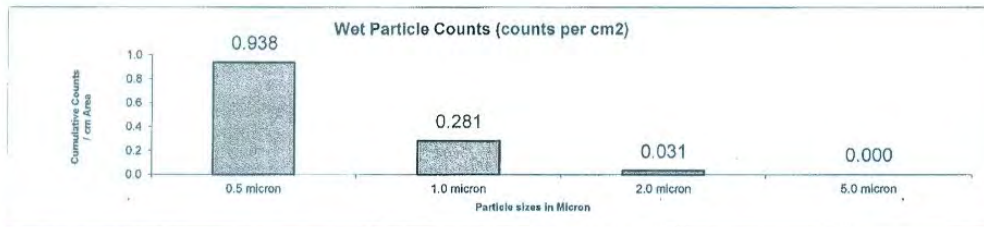

Total Particle (≥0.5): 1.250 Cts/cm²

SPEC: ≥ 0.5u < 100 COUNTS/CM²

Tested By: SUHAIDA
Date: 26.10.2020

Verified By: RUDY
Date: 26.10.2020





TIP CORPORATION SDN BHD

Lot 2288, Jalan P4/8, Bandar Teknologi Kajang,
Semenyih, 43500 Selangor, Malaysia.
Tel: +603-8723 7889
E-mail: sales@tipcorp.com Website: www.tipcorp.com
SST No: W24-1808-21017734



FORM QC-21

LPC Test Report

Item: C/R EASY PEEL-PRT Lot No: K34514(Outgoing B)
Testing Date: 26.10.2020 Size: 152.4 X 304.8 X 0.07MM
Customer: SAFESKIN Method: BY HAND
Machine: BS-5

Blank Particle Counts (Cumulative)

	Blank Cts 1 Counts	Blank Cts 2 Counts	Blank Ct 3 Counts	Average Blank (A) Counts
0.5 micron	5.0	2.0	4.0	3.7
1.0 micron	0.0	0.0	0.0	0.0
2.0 micron	0.0	0.0	0.0	0.0
5.0 micron	0.0	0.0	0.0	0.0
				0.0 Total counts 3.7

Washed Sample Particle Counts (Cumulative)

	Washed Cts 1 Counts	Washed Cts 2 Counts	Washed Cts 3 Counts	Average Washed (B) Counts
0.5 micron	19.0	15.0	17.0	17.0
1.0 micron	4.0	3.0	2.0	3.0
2.0 micron	1.0	1.0	1.0	1.0
5.0 micron	1.0	1.0	0.0	0.7
				1.0 Total counts 21.7

(C) Wet Particle Counts

Ave. Washed - Ave. Blank (C = B - A)

0.5 micron	13.3
1.0 micron	3.0
2.0 micron	1.0
5.0 micron	0.7

(D) Total Vol. for Washed Sample

Washed Volume (ml) 400 ml

(E) Sampling size

5 ml

(F) Total Area of Plastic

Total Washed Area 853 cm²

(G) Particle counts per ml (G = C / E)

0.5 micron	2.667
1.0 micron	0.600
2.0 micron	0.200
5.0 micron	0.133

(H) Total Wet Part Cts / cm² (H = G X D / F)

0.5 micron	1.250
1.0 micron	0.281
2.0 micron	0.094
5.0 micron	0.063

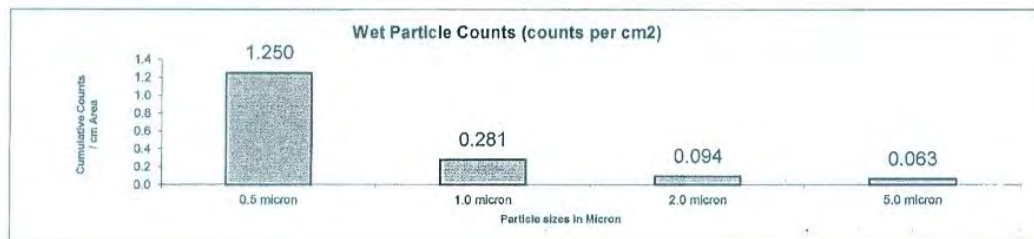

Cts/cm²

Total Particle (≥0.5): 1.688

SPEC: ≥ 0.5u <100 COUNTS/CM²

Tested By: SUHAIDA

Date: 26.10.2020

Verified By: RUDY

Date: 26.10.2020





TIP CORPORATION SDN BHD

Lot 2288, Jalan P4/8, Bandar Teknologi Kajang,
Semenyih, 43500 Selangor, Malaysia.
Tel: +603-8723 7889
E-mail: sales@tipcorp.com Website: www.tipcorp.com
SST No: W24-1808-21017734



FORM QC-21

LPC Test Report

Item: C/R EASY PEEL-PRT Lot No: K34514(Outgoing C)
Testing Date: 26.10.2020 Size: 152.4 X 304.8 X 0.07MM
Customer: SAFESKIN Method: BY HAND
Machine: BS-5

Blank Particle Counts (Cumulative)

	Blank Cts 1 Counts	Blank Cts 2 Counts	Blank Ct 3 Counts	Average Blank (A) Counts	
0.5 micron	4.0	3.0	3.0	3.3	
1.0 micron	0.0	0.0	0.0	0.0	
2.0 micron	0.0	0.0	0.0	0.0	
5.0 micron	0.0	0.0	0.0	0.0	3.3
				0.0 Total counts	0.0

Washed Sample Particle Counts (Cumulative)

	Washed Cts 1 Counts	Washed Cts 2 Counts	Washed Cts 3 Counts	Average Washed (B) Counts	
0.5 micron	20.0	11.0	18.0	16.3	
1.0 micron	8.0	3.0	3.0	4.7	
2.0 micron	3.0	1.0	0.0	1.3	22.3
5.0 micron	0.0	0.0	0.0	0.0	

(C) Wet Particle Counts

Ave. Washed - Ave. Blank (C = B - A)

0.5 micron	13.0
1.0 micron	4.7
2.0 micron	1.3
5.0 micron	0.0

(D) Total Vol. for Washed Sample

Washed Volume (ml) 400 ml

(E) Sampling size

5 ml

(F) Total Area of Plastic

Total Washed Area 853 cm²

(G) Particle counts per ml (G = C / E)

0.5 micron	2.600
1.0 micron	0.933
2.0 micron	0.267
5.0 micron	0.000

(H) Total Wet Part Cts / cm² (H = G X D / F)

0.5 micron	1.219
1.0 micron	0.438
2.0 micron	0.125
5.0 micron	0.000

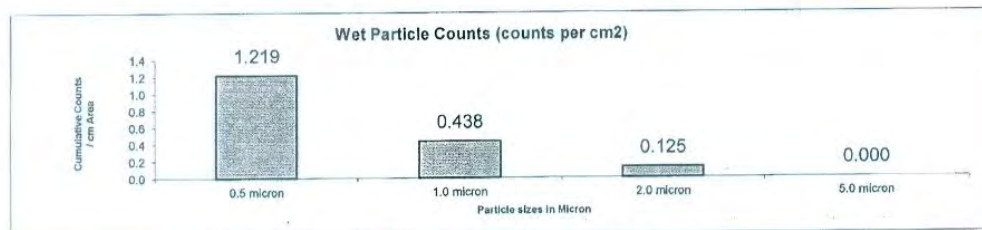

Total Particle (≥0.5) : 1.782 Cts/cm²

SPEC: ≥ 0.5u <100 COUNTS/CM²

Tested By : SUHAIDA
Date : 26.10.2020

Verified By : RUDY
Date : 26.10.2020

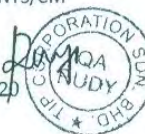



TIP CORPORATION SDN BHD

Lot 2288, Jalan P4/8, Bandar Teknologi Kajang,
Semenyih, 43500 Selangor, Malaysia.
Tel: +603-8723 7889

E-mail: sales@tipcorp.com Website: www.tipcorp.com
SST No: W24-1808-21017734



FORM QC-21

LPC Test Report

Item: C/R LDPE WALLET Lot No: K55532
Testing Date: 09.11.2020 Size: 220X340X0.06MM
Customer: SAFESKIN Method: BY HAND

Blank Particle Counts (Cumulative)

	Blank Cts 1 Counts	Blank Cts 2 Counts	Blank Ct 3 Counts	Average Blank (A) Counts	
0.5 micron	1.0	0.0	1.0	0.7	
1.0 micron	0.0	0.0	0.0	0.0	
2.0 micron	0.0	0.0	0.0	0.0	
0.5 micron	0.0	0.0	0.0	0.0	Total counts 0.7

Washed Sample Particle Counts (Cumulative)

	Washed Cts 1 Counts	Washed Cts 2 Counts	Washed Cts 3 Counts	Average Washed (B) Counts	
0.5 micron	60.0	58.0	52.0	56.7	
1.0 micron	13.0	21.0	18.0	17.3	
2.0 micron	4.0	5.0	6.0	5.0	
0.5 micron	2.0	0.0	3.0	1.7	Total counts 80.7

(C) Wet Particle Counts

Ave. Washed - Ave. Blank (C = B - A)

0.5 micron	56.0
1.0 micron	17.3
2.0 micron	5.0
0.5 micron	1.7

(D) Total Vol. for Washed Sample

Washed Volume (ml) 400 ml

(E) Sampling size 5 ml

(F) Total Area of Plastic

Total Washed Area 1496 cm²

(G) Particle counts per ml (G = C / E)

0.5 micron	11.200
1.0 micron	3.467
2.0 micron	1.000
0.5 micron	0.333

(H) Total Wet Part Cts / cm² (H = G X D / F)

0.5 micron	2.995
1.0 micron	0.927
2.0 micron	0.267
0.5 micron	0.089

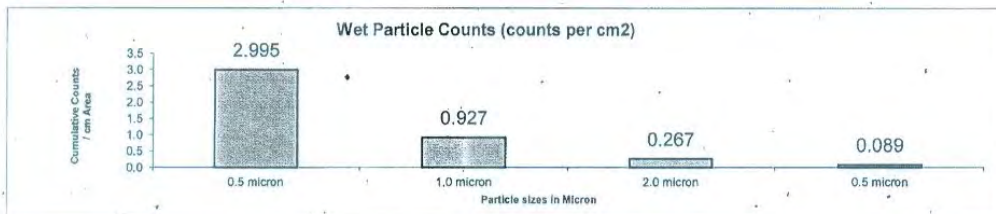

Cts/cm2

Total Particle (≥0.5): 4.278

SPEC: ≥ 0.5u <100 COUNTS/CM²

Tested By: SUHAIDA
Date: 09.11.2020

Verified By: RUDY
Date: 09.11.2020





TIP CORPORATION SDN BHD

Lot 2288, Jalan P4/8, Bandar Teknologi Kajang,
Semenyih, 43500 Selangor, Malaysia.
Tel: +603-8723 7889
E-mail: sales@tipcorp.com Website: www.tipcorp.com
SST No: W24-1808-21017734



FORM QC-21

LPC Test Report

Item:	C/R LDPE WALLET	Lot No:	K55753
Testing Date:	09.11.2020	Size:	220X340X0.06MM
Customer :	SAFESKIN	Method:	BY HAND
<u>Blank Particle Counts (Cumulative)</u>		KCCS-17	
	Blank Cts 1	Blank Cts 2	Blank Ct 3
	Counts	Counts	Counts
0.5 micron	6.0	0.0	1.0
1.0 micron	2.0	0.0	0.0
2.0 micron	0.0	0.0	0.0
5.0 micron	0.0	0.0	0.0
	Average Blank (A)		
	Counts		
	0.0 Total counts 3.0		

<u>Washed Sample Particle Counts (Cumulative)</u>			
	Washed Cts 1	Washed Cts 2	Washed Cts 3
	Counts	Counts	Counts
0.5 micron	56.0	45.0	72.0
1.0 micron	16.0	23.0	32.0
2.0 micron	4.0	6.0	9.0
5.0 micron	2.0	0.0	2.0
	Average Washed (B)		
	Counts		
	1.3 Total counts 89.0		

(C) Wet Particle Counts

Ave. Washed - Ave. Blank (C = B - A)

0.5 micron	55.3
1.0 micron	23.0
2.0 micron	6.3
5.0 micron	1.3

(D) Total Vol. for Washed Sample

Washed Volume (ml)	400 ml
----------------------	--------

(E) Sampling size

	5 ml
--	------

(F) Total Area of Plastic

Total Washed Area	1496 cm ²
-------------------	----------------------

(G) Particle counts per ml (G = C / E)

micron	11.067
1.0 micron	4.600
2.0 micron	1.267
5.0 micron	0.267

(H) Total Wet Part Cts / cm² (H = G X D / F)

0.5 micron	2.959
1.0 micron	1.230
2.0 micron	0.339
5.0 micron	0.071

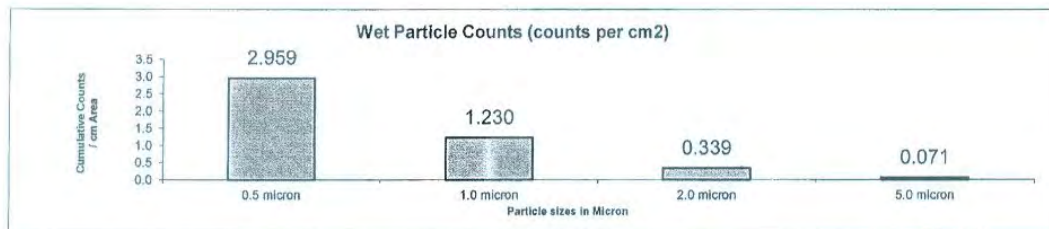

Cts/cm²
Total Particle (≥0.5) : 4.599

SPEC: ≥ 0.5u ≤ 100 COUNTS/CM²

Tested By : SUHAIDA
Date : 09.11.2020

Verified By : RUDY
Date : 09.11.2020

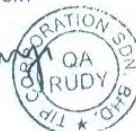



TIP CORPORATION SDN BHD

Lot 2288, Jalan P4/8, Bandar Teknologi Kajang,
Semenyih, 43500 Selangor, Malaysia.
Tel: +603-8723 7889
E-mail: sales@tipcorp.com Website: www.tipcorp.com
SST No: W24-1808-21017734



FORM QC-21

LPC Test Report

Item: C/R LDPE WALLET Lot No: K55752
Testing Date: 09.11.2020 Size: 220X340X0.06MM
Customer: SAFESKIN Method: BY HAND
Blank Particle Counts (Cumulative) KCCS-17

	Blank Cts 1	Blank Cts 2	Blank Ct 3	Average Blank (A)
	Counts	Counts	Counts	Counts
0.5 micron	9.0	6.0	5.0	6.7
1.0 micron	0.0	0.0	1.0	0.3
2.0 micron	0.0	0.0	0.0	0.0
5.0 micron	0.0	0.0	0.0	0.0
				0.0 Total counts

Washed Sample Particle Counts (Cumulative)

	Washed Cts 1	Washed Cts 2	Washed Cts 3	Average Washed (B)
	Counts	Counts	Counts	Counts
0.5 micron	65.0	96.0	98.0	86.3
1.0 micron	22.0	25.0	28.0	25.0
2.0 micron	8.0	6.0	6.0	6.7
5.0 micron	2.0	3.0	0.0	1.7
				1.7 Total counts

(C) Wet Particle Counts

Ave. Washed - Ave. Blank (C = B - A)

0.5 micron	79.7
1.0 micron	24.7
2.0 micron	6.7
5.0 micron	1.7

(D) Total Vol. for Washed Sample

Washed Volume (ml) 400 ml

(E) Sampling size 5 ml

(F) Total Area of Plastic

Total Washed Area 1496 cm²

(G) Particle counts per ml (G = C / E)

0.5 micron	15.933
1.0 micron	4.933
2.0 micron	1.333
5.0 micron	0.333

(H) Total Wet Part Cts / cm² (H = G X D / F)

0.5 micron	4.260
1.0 micron	1.319
2.0 micron	0.357
5.0 micron	0.089

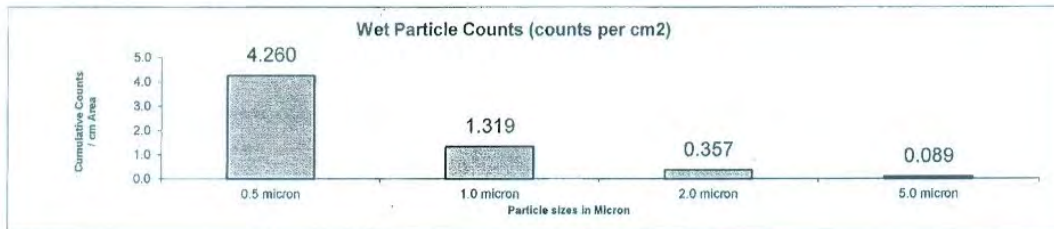

Cts/cm²

Total Particle (≥0.5): 6.025

SPEC: ≥ 0.5u <100 COUNTS/CM²

Tested By: SUHAIDA
Date: 09.11.2020

Verified By: RUDY
Date: 09.11.2020





TIP CORPORATION SDN BHD Reg No: 198901010228 (187530-A)
 Lot 2288, Jalan P4/8, Bandar Teknologi Kajang, Semenyih, 43500 Selangor, Malaysia.
 Tel: +603-8723 7889
 E-mail: sales@tipcorp.com Website: www.tipcorp.com
 SST No: W24-1808-21017734



FORM QC-21

LPC Test Report

Item: C/R LDPE WALLET Lot No: K55751
 Testing Date: 09.11.2020 Size: 18"X0.06MM(18"X18")
 Customer: SAFESKIN Method: BY SHAKER
 Machine: KL-2

Blank Particle Counts (Cumulative)

	Blank Cts 1 Counts	Blank Cts 2 Counts	Blank Ct 3 Counts	Average Blank (A) Counts	
0.5 micron	2.0	1.0	0.0	1.0	
1.0 micron	0.0	1.0	0.0	0.3	
2.0 micron	0.0	0.0	0.0	0.0	
5.0 micron	0.0	0.0	0.0	0.0	
				0.0 Total counts	1.3

Wash Sample Particle Counts (Cumulative)

	Washed Cts 1 Counts	Washed Cts 2 Counts	Washed Cts 3 Counts	Average Washed (B) Counts	
0.5 micron	289.0	258.0	286.0	277.7	
1.0 micron	120.0	92.0	111.0	107.7	
2.0 micron	39.0	51.0	33.0	41.0	
5.0 micron	9.0	5.0	6.0	6.7	
				6.7 Total counts	433.0

(C) Wet Particle Counts

Ave. Washed - Ave. Blank (C = B - A)

0.5 micron	276.7
1.0 micron	107.3
2.0 micron	41.0
5.0 micron	6.7

(D) Total Vol. for Washed Sample

Washed Volume (ml) 1000 ml

(E) Sampling size 5 ml

(F) Total Area of Plastic

Total Washed Area 4181 cm²

(G) Particle counts per ml (G = C / E)

0.5 micron	55.333
1.0 micron	21.467
2.0 micron	8.200
5.0 micron	1.333

(H) Total Wet Part Cts / cm² (H = G X D / F)

0.5 micron	13.234
1.0 micron	5.134
2.0 micron	1.961
5.0 micron	0.319

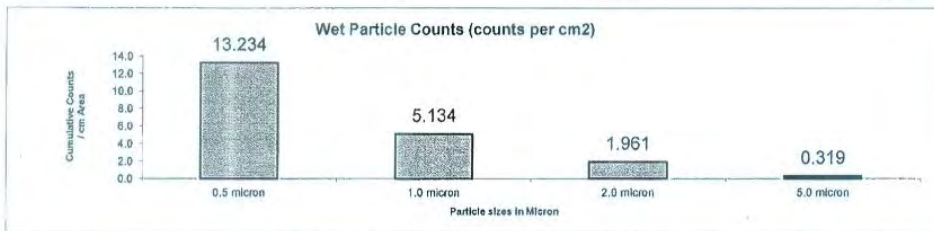

Total Particle (≥0.5) : 20.649 Cts/cm²

SPEC: ≥ 0.5u ≤30 COUNTS/CM²
 SPEC: ≥ 0.5u ≤10 COUNTS/CM²

Tested By : SUHAIDA
 Date : 09.11.2020

Verified By : RUDY
 Date : 09.11.2020



WALLET



TIP CORPORATION SDN BHD

Lot 2288, Jalan P4/8, Bandar Teknologi Kajang,
Semenyih, 43500 Selangor, Malaysia.
Tel: +603-8723 7889
E-mail: sales@tipcorp.com Website: www.tipcorp.com
SST No: W24-1808-21017734



FORM QC-21

LPC Test Report

Item: C/R LDPE WALLET Lot No: K55749
Testing Date: 09.11.2020 Size: 220X340X0.06MM
Customer: SAFESKIN Method: BY HAND

Blank Particle Counts (Cumulative)

	Blank Cts 1 Counts	Blank Cts 2 Counts	Blank Ct 3 Counts	Average Blank (A) Counts	
0.5 micron	3.0	3.0	2.0	2.7	
1.0 micron	0.0	0.0	0.0	0.0	
2.0 micron	0.0	0.0	0.0	0.0	
0.5 micron	0.0	0.0	0.0	0.0 Total counts	2.7

Washed Sample Particle Counts (Cumulative)

	Washed Cts 1 Counts	Washed Cts 2 Counts	Washed Cts 3 Counts	Average Washed (B) Counts	
0.5 micron	48.0	58.0	72.0	59.3	
1.0 micron	17.0	18.0	14.0	16.3	
2.0 micron	9.0	10.0	3.0	7.3	
0.5 micron	0.0	2.0	0.0	0.7 Total counts	83.7

(C) Wet Particle Counts

Ave. Washed - Ave. Blank (C = B - A)

0.5 micron	56.7
1.0 micron	16.3
2.0 micron	7.3
0.5 micron	0.7

(D) Total Vol. for Washed Sample

Washed Volume (ml) 400 ml

(E) Sampling size 5 ml

(F) Total Area of Plastic

Total Washed Area 1496 cm²

(G) Particle counts per ml (G = C / E)

0.5 micron	11.333
1.0 micron	3.267
2.0 micron	1.467
0.5 micron	0.133

(H) Total Wet Part Cts / cm² (H = G X D / F)

0.5 micron	3.030
1.0 micron	0.873
2.0 micron	0.392
0.5 micron	0.036

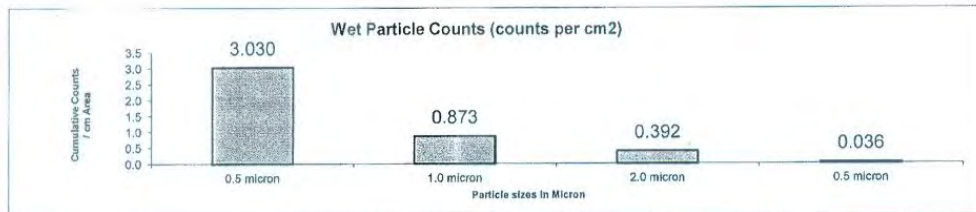

Total Particle (≥0.5) : 4.332 Cts/cm²

SPEC: ≥ 0.5μ ≤ 100 COUNTS/CM²

Tested By : SUHAIDA
Date : 09.11.2020

Verified By : RUDY
Date : 09.11.2020



DOSE MAPPING REPORT

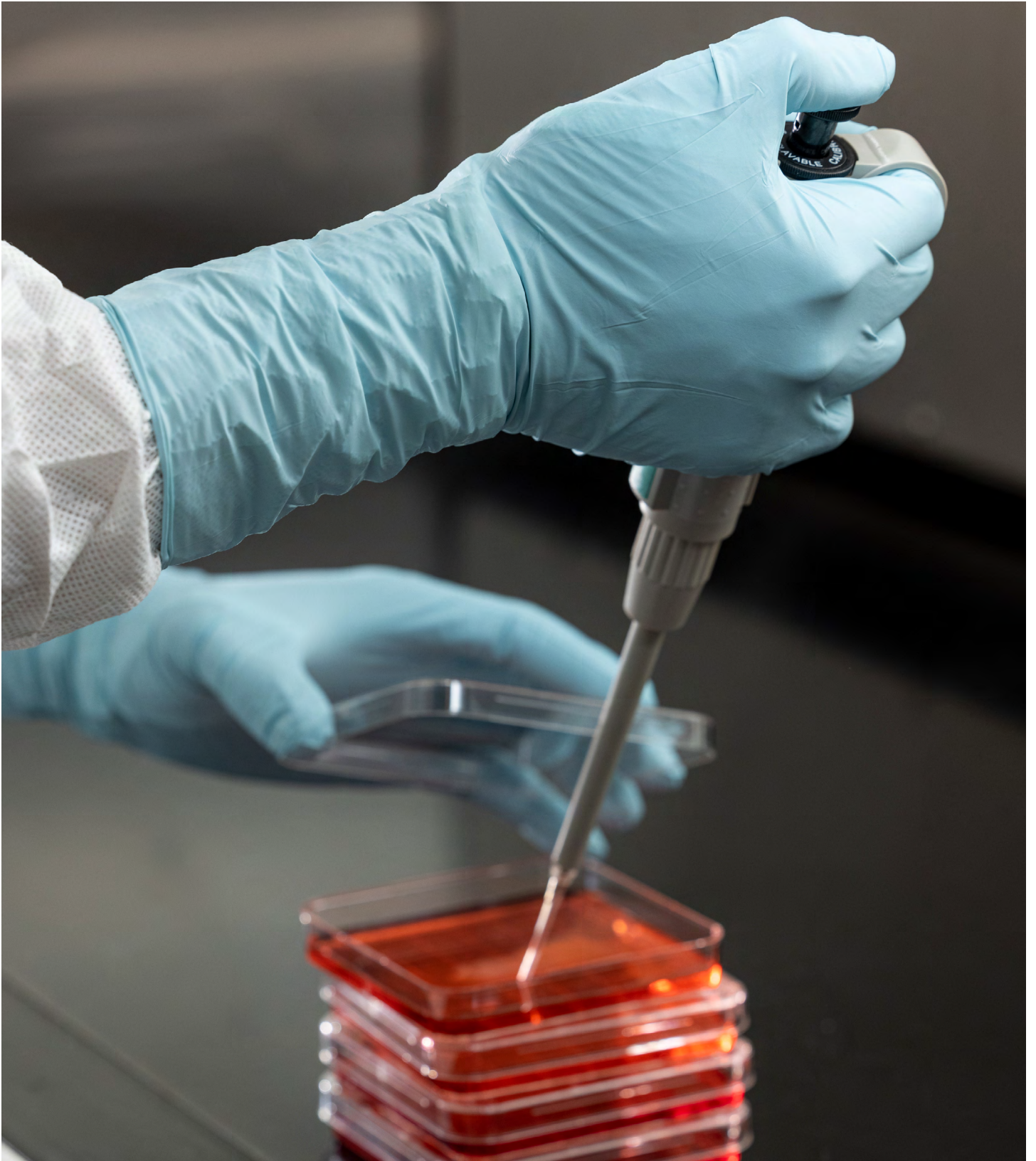

Safeskin Medical & Scientific (Thailand) Ltd

Please find enclosed with our compliments, the completed process validation report in accordance with EN ISO 11137-1:2015 for the products as below:

Product name: **HALYARD*PUREZERO* HG3 Sterile Light Blue Nitrile Gloves - Pairs**
The validation ref no: **0.0968 Rev 01**

We would appreciate you quoting the product name as above in your PO/DO/reference documents to STERIS, this will aid in identifying your products prior to processing.

Your sincerely,



07 May 2021
Yow Hueh Koon
Malaysia Radiation Validation Manager
STERIS Applied Sterilization Technologies
Tel: +603 3101 3366
Email: huehkoon_yow@steris.com

Customer Acknowledge,

Name :
Designation :
(Please sign this section and scan a copy to huehkoon_yow@steris.com)



Applied Sterilization Technologies

DOSE MAPPING REPORT
Safeskin Medical & Scientific (Thailand) Ltd
For

HALYARD*PUREZERO* HG3
Sterile Light Blue Nitrile Gloves - Pairs

Validation Report Number : 0.0968 Rev 01

Performance Qualification STERIS Kuala Ketil
Summary of Performance Qualification:

Customer Name : Safeskin Medical & Scientific (Thailand) Ltd
 Report Ref. : 0.0968 Rev 01
 Issue Date : 29.04.2021

Product Description: HALYARD*PUREZERO* HG3 Sterile Light Blue Nitrile
 Gloves - Pairs
 Type of package: Corrugated carton
 Carton dimension : 345 mm (L) x 285 mm (W) x 390 mm (H) (12 ctns/tote)

Method : ISO/ASTM 52303: 2015 (E)
 Reference Standard : EN ISO 11137-1: 2015
 Reference Procedure : QWI 24 Rev 12 Dose Mapping

Dose Specification:



Minimum dose (kGy) : 25.0
 Maximum dose (kGy) : 50.0

Requirement	Minimum specification	Maximum specification
Dose at DRef	27.0	45.9
Dwell time(s)	123	205
Number of Xs	32	54
Correction Factor (Rmin/Rmax)	0.927	1.089

Conclusion

The delivered dose in the product presentation illustrated on page 4 and 5 achieves the requested dose specification of minimum and maximum specification. In order to meet this specification during routine processing the recorded dose at Dref must be as above specification. This incorporates an estimation of uncertainty associated with the measurement system.

Authorisation

	Position	Signature	Date
Prepared by	Malaysia Radiation Validation Manager		06 May 2021
Reviewed by	Operation Management or designee		07/05/2021
Approved by	QA Management or designee		07/05/2021

Note:

It is the responsibility of the Customer to routinely provide product in the presentation and orientation outlined in this report. This performance qualification validates the delivery of radiation doses only. Validation of the sterilisation effect and radiation induced material effects, if any, are not addressed by this qualification.

Performance Qualification STERIS Kuala Ketil

Product description: **HALYARD*PUREZERO* HG3 Sterile Light Blue Nitrile Gloves - Pairs**

Qualification data is obtained by placing 4034 PW Red dosimeters in a defined pattern throughout a STERIS tote loaded with product.

The performance qualification is conducted in triplicate with the dosimeters placed throughout the product to assess both the dose distribution and determine the variability of the absorbed dose measurements, when processed under the same processing conditions.

Following processing the relationship between D_{ref} / D_{min} and D_{ref} / D_{max} are calculated to determine an acceptable D_{ref} processing range.

D_{ref} processing range is calculated by multiplying the R_{min} by the Customer minimum specification and the R_{max} by the customer maximum specification .

During routine processing if the D_{ref} value falls within this range then processing is deemed as meeting the required specification:

D_{ref} Minimum = Expected value of R_{min} x Minimum Dose Required

D_{ref} Maximum = Expected value of R_{max} x Maximum Dose Required

Uncertainty

The specification for D_{ref} incorporates an estimation of the uncertainty associated with the measurement system. Uncertainty has been calculated using the method outlined in ASTM 52303:2015 (E). This method provides a confidence level of 95%

Definitions

D_{ref}	- Reference Dose
D_{min}	- Minimum Dose
D_{max}	- Maximum Dose
R_{min}	- D_{ref} / D_{min} ratio
R_{max}	- D_{ref} / D_{max} ratio
CV%	- Coefficient of Variance
C060	- Cobalt 60

Performance Qualification STERIS Kuala Ketil

Applied Sterilization Technologies

Validation Ref : 0.0968 Rev 01

Product: HALYARD*PUREZERO* HG3 Sterile Light Blue Nitrile Gloves - Pairs **LOW DENSITY**

Analysis for the Calculation of Release Specification Incorporating Uncertainties

Position	PQ1	PQ2	PQ3	Mean	Stdev	CV	Sum of Squared Differences
A11	32.2	32.7	32.4	32.4	0.25	0.77	0.13
A21	32.1	32.2	32.3	32.2	0.10	0.31	0.02
A31	30.7	31.7	33.0	31.8	1.15	3.62	2.66
A41	31.9	32.2	32.0	32.0	0.15	0.47	0.05
A51	33.5	33.7	33.2	33.5	0.25	0.75	0.13
A15	33.7	33.9	33.3	33.6	0.31	0.92	0.19
A25	32.5	33.0	32.7	32.7	0.25	0.76	0.13
A35	33.5	33.8	33.4	33.6	0.21	0.63	0.09
A45	34.0	34.1	34.3	34.1	0.15	0.44	0.05
A55	33.0	33.1	33.2	33.1	0.10	0.30	0.02
A19	33.3	34.2	33.5	33.7	0.47	1.39	0.45
A29	35.4 √-MAX	34.8	34.1	34.8	0.65	1.87	0.85
A39	34.1	34.4	34.9	34.5	0.40	1.16	0.33
A49	34.3	35.2	35.0	34.8	0.47	1.35	0.45
A59	35.3	35.6 √-MAX	35.1 √-MAX	35.3	0.25	0.71	0.13
B11	30.7	31.2	31.2	31.0	0.29	0.94	0.17
B21	31.2	31.1 √-MIN	31.1	31.1	0.06	0.19	0.01
B31	30.4 √-MIN	31.4	31.1	31.0	0.51	1.65	0.53
B41	31.0	31.1 √-MIN	31.4	31.2	0.21	0.67	0.09
B51	30.8	32.0	30.4 √-MIN	31.1	0.83	2.67	1.39
B15	32.7	31.8	31.5	32.0	0.62	1.94	0.78
B25	32.0	31.8	32.5	32.1	0.36	1.12	0.26
B35	31.8	31.7	31.0	31.5	0.44	1.40	0.38
B45	31.7	31.3	32.0	31.7	0.35	1.10	0.25
B55	31.2	33.0	32.5	32.2	0.93	2.89	1.73
B19	31.7	31.7	31.1	31.5	0.35	1.11	0.24
B29	31.6	32.0	31.9	31.8	0.21	0.66	0.09
B39	32.3	32.1	31.3	31.9	0.53	1.66	0.56
B49	31.1	31.6	31.3	31.3	0.25	0.80	0.13
B59	31.2	31.9	32.4	31.8	0.60	1.89	0.73

Pooled variance (s²overall) **0.22**
 Minimum detectable difference (δ) **0.64**
 Mean Minimum dose (DMin) **31.0 B11, B31**
 Mean Maximum dose (DMax) **35.3 A59**

Expected value of Rmin (Dref/Dmin) **1.045 ***
 Expected value of Rmax (Dref/Dmax) **0.918 ***

DRef Ratio :	
1/Rmin	0.957
1/Rmax	1.089

Remarks: * incorporates an estimation of the uncertainty
 Customer Spec Min: **25.0** Max: **50.0**
 D reference Min: **26.1** Max: **45.9**
 Dose Uniformity Ratio (DUR): **1.14**

Performance Qualification STERIS Kuala Ketil

Applied Sterilization Technologies

Validation Ref : 0.0968 Rev 01

Product: HALYARD*PUREZERO* HG3 Sterile Light Blue Nitrile Gloves - Pairs **HIGH DENSITY**

Analysis for the Calculation of Release Specification Incorporating Uncertainties

Position	PQ1		PQ2		PQ3		Mean	Stdev	CV	Sum of Squared Difference
A11	32.2		32.7		34.0		33.0	0.93	2.82	1.73
A21	32.0		31.9		32.5		32.1	0.32	1.00	0.21
A31	30.6		31.5		33.2		31.8	1.32	4.15	3.49
A41	32.4		32.1		32.4		32.3	0.17	0.53	0.06
A51	33.3		32.8		33.3		33.1	0.29	0.88	0.17
A15	33.1		33.9		34.3		33.8	0.61	1.80	0.75
A25	31.9		32.4		32.5		32.3	0.32	0.99	0.21
A35	33.3		33.7		34.2		33.7	0.45	1.34	0.41
A45	33.3		34.2		34.7		34.1	0.71	2.08	1.01
A55	32.2		32.8		34.5		33.2	1.19	3.58	2.85
A19	33.1		33.9		33.5		33.5	0.40	1.19	0.32
A29	33.6		34.3		35.1	√-MAX	34.3	0.75	2.19	1.13
A39	34.7	√-MAX	34.6		35.0		34.8	0.21	0.60	0.09
A49	34.4		35.1	√-MAX	35.0		34.8	0.38	1.09	0.29
A59	34.1		35.1	√-MAX	35.0		34.7	0.55	1.59	0.61
B11	29.9		31.1		30.7		30.6	0.61	1.99	0.75
B21	30.2		31.7		31.8		31.2	0.90	2.88	1.61
B31	30.1		30.6	√-MIN	31.2		30.6	0.55	1.80	0.61
B41	31.5		31.8		29.8	√-MIN	31.0	1.08	3.48	2.33
B51	29.6	√-MIN	30.8		31.7		30.7	1.05	3.42	2.22
B15	31.3		32.4		32.1		31.9	0.57	1.79	0.65
B25	31.3		31.8		32.1		31.7	0.40	1.26	0.33
B35	31.1		31.7		31.5		31.4	0.31	0.99	0.19
B45	31.3		31.7		31.9		31.6	0.31	0.98	0.19
B55	31.1		32.1		33.7		32.3	1.31	4.06	3.44
B19	30.6		32.1		32.0		31.6	0.84	2.66	1.41
B29	30.7		31.9		31.2		31.3	0.60	1.92	0.73
B39	30.5		31.6		31.5		31.2	0.61	1.96	0.74
B49	30.7		31.4		31.8		31.3	0.56	1.79	0.62
B59	31.2		31.2		32.0		31.5	0.46	1.46	0.43

Pooled variance (s^2 overall) **0.49**
 Minimum detectable difference (δ) **0.95**
 Mean Minimum dose (DMin) **30.6 B11, B31**
 Mean Maximum dose (DMax) **34.8 A39, A49**

Expected value of Rmin (Dref/Dmin) **1.079 ***
 Expected value of Rmax (Dref/Dmax) **0.948 ***

Dref Ratio :	
1/Rmin	0.927
1/Rmax	1.055

Remarks: * incorporates an estimation of the uncertainty

Customer Spec Min: **25.0** Max: **50.0**
 D reference Min: **27.0** Max: **47.4**
 Dose Uniformity Ratio (DUR): **1.14**

Performance Qualification STERIS Kuala Ketil

Applied Sterilization Technologies

Product Detail **Validation Ref** : 0.0968 Rev 01

Customer Name : **Safeskin Medical & Scientific (Thailand) Ltd**

Issue Date : **29.04.2021**

Product Description : **HALYARD*PUREZERO* HG3 Sterile Light Blue Nitrile Gloves - Pairs**

Plant Batch No : **S12562825-1-1 (LD - low density, size 6.0)**
S12562825-1-2 (HD - high density, size 10.0)

Current Cobalt Loading	: 4,591,067 Curries	Weight (LD)	: 8.00 kg
Standard Plant Dwell Time	: 146 Sec	Weight (HD)	: 9.90 kg
Actual Dwell Time	: 146 Sec	Length	: 345 mm
Number of Xs	: 38.0	Width	: 285 mm
Value of X	: 3.83	Height	: 390 mm
Type of package	: Corrugated carton	Density (LD)	: 0.209 g/cm ³
Dose Range Specification (kGy)	: 25 Min	Density (HD)	: 0.258 g/cm ³
	50 Max	Tote Fit	: 12 ctn/tote

Low Density Dwell Time Control

Minimum dwell time to achieve	Minimum dose	Maximum dose
First tote	120 ✓	206
Second tote	117	205 ✓
Third tote	120 ✓	208

High Density Dwell Time Control

Minimum dwell time to achieve	Minimum dose	Maximum dose
First tote	123 ✓	210
Second tote	119	208 ✓
Third tote	122	208 ✓

Reference Procedures: : QWI 24 Rev 12 Dose Mapping
 Method : ISO/ASTM 52303: 2015 (E)
 Reference Standard : EN ISO 11137-1: 2015

Performance Qualification STERIS Kuala Ketil

Applied Sterilization Technologies

Validation Ref : 0.0968 Rev 01

Customer Name : **Safeskin Medical & Scientific (Thailand) Ltd**

Type of Package : **Corrugated carton**

Product Description : **HALYARD*PUREZERO* HG3 Sterile Light Blue Nitrile Gloves - Pairs**

Issue Date : **29.04.2021**

This performance qualification relates only to the above product loaded in the configuration outlined below.

Carton dimension : **345 mm (L) x 285 mm (W) x 390 mm (H) (12 ctns/tote)**

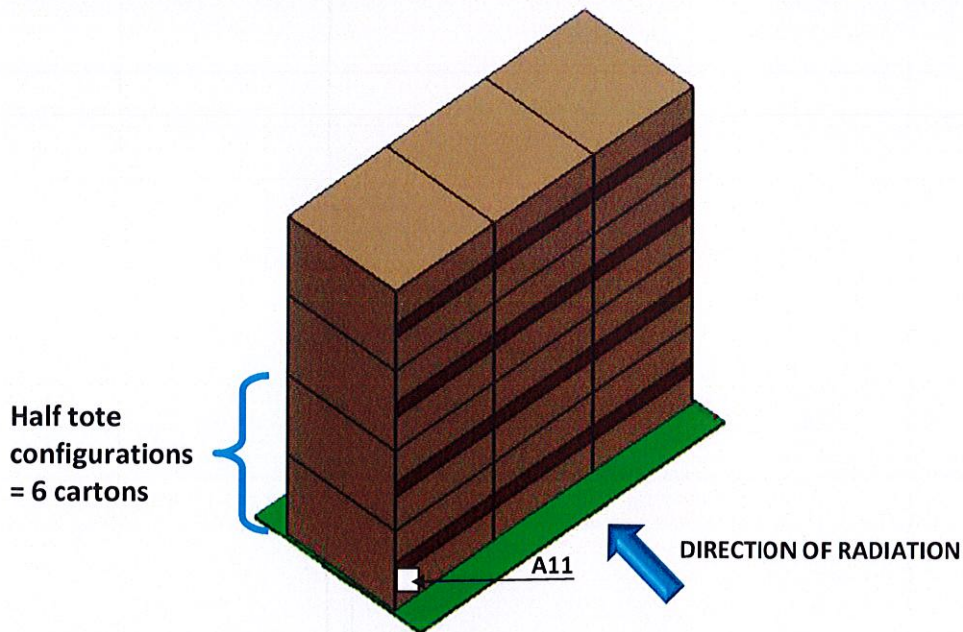

Remark : A11 is the routine process monitoring

Authorised By:	Signature	Date
Radiation Technology Management or designee		06 May 2021

Performance Qualification STERIS Kuala Ketil

Applied Sterilization Technologies

Validation Ref : 0.0968 Rev 01

Customer Name : Safeskin Medical & Scientific (Thailand) Ltd
 Type of Package : Corrugated carton
 Product Description : HALYARD*PUREZERO* HG3 Sterile Light Blue Nitrile Gloves - Pairs
 Issue Date : 29.04.2021

This performance qualification relates only to the above product loaded in the configuration outlined below.

TOTE CHARACTERISTICS AND ORIENTATION

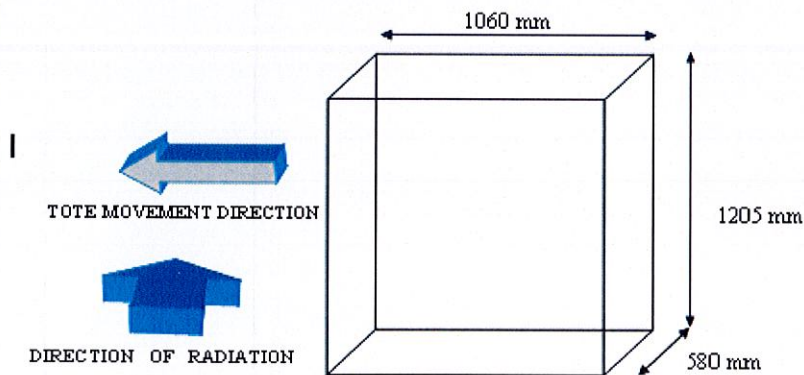

LOCATION OF DOSIMETERS

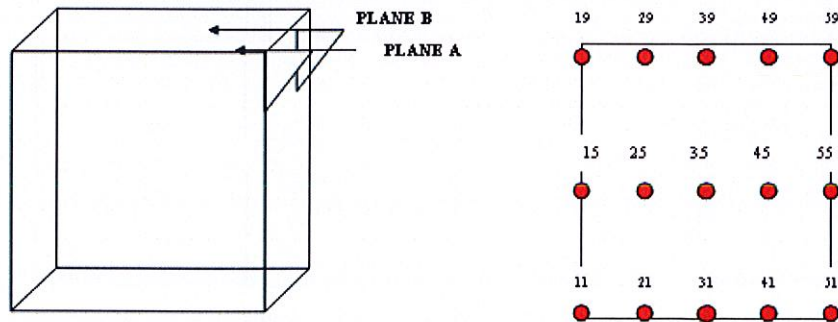

As per our Operational Qualification Report, from latest source loading replenishment, the dose distribution in the front plane (plane A) is the same as in the back plane (plane C).

Customer Name: **Safeskin Medical & Scientific (Thailand) Ltd**

Orientation of product within the package

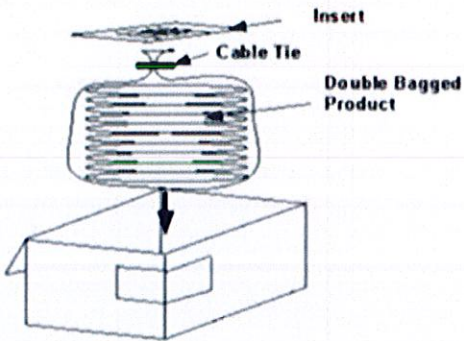

Dosimeter position

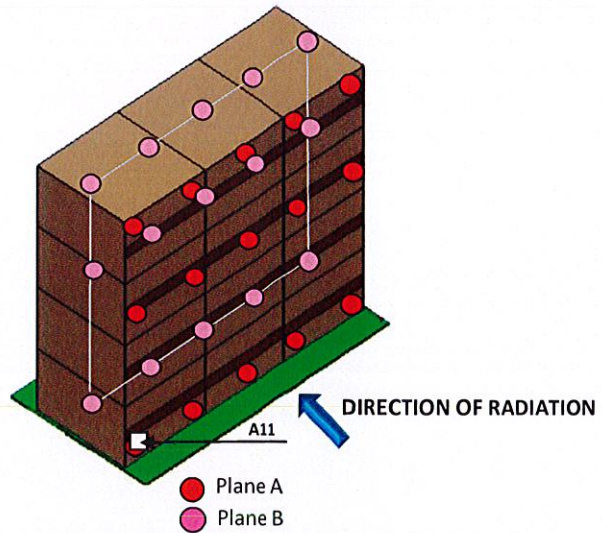

Remark : A11 is the routine process monitoring

Authorised By:	Signature	Date
Radiation Technology Management or designee		06 May 2021

SAFETY DATA SHEET





SAFETY DATA SHEET

HALYARD* PUREZERO* HG3 Nitrile Gloves

1. IDENTIFICATION

Product Name: **HALYARD* PUREZERO* HG3 Nitrile Gloves Product**

Number: Various

Date Prepared:	6/24/2021
Manufacturer:	O&M Halyard, Inc. 1 Edison Dr. Alpharetta, Georgia 30005
Telephone: MEDICAL EMERGENCY: TRANSPORTATION EMERGENCY: INFORMATION:	Call 911 or your local Emergency Room or Poison Control Services Chemtrec 1-800-424-9300 or 1-703-527-3887 (collect calls accepted) 1-844-HALYARD

Product Use: Protective gloves.

2. HAZARDS IDENTIFICATION

GHS Classification: Not Hazardous. These products are manufactured articles or articles as this term is defined in the OSHA Hazard Communication Standard (20CFR 1910.1200), EU REACH, Canadian WHMIS, Australia WHS and the GHS. These products are out of the scope of the GHS and no SDS or labeling are required.

GHS Labeling: No GHS labeling required.

3. COMPOSITION/INFORMATION ON INGREDIENTS

<i>Chemical Name</i>	<i>CAS-No./ EINECS-No</i>	<i>%</i>	<i>GHS Classification:</i>
Non-Hazardous Ingredients	Mixture	100	Not Hazardous

4. FIRST AID MEASURES

Inhalation: No first aid needed.

Skin contact: No first aid needed. These products are intended to be used in contact with the skin.

Eye contact: No first aid needed.

Ingestion: Not a relevant route of exposure.

Most Important symptoms and effects, both acute and delayed: No adverse effects.

Indication of any immediate medical attention and special treatment needed: None required.

**5. FIRE-FIGHTING MEASURES**

Suitable (and unsuitable) Extinguishing Media: Use media suitable for surrounding materials.

Specific Hazards Arising from the Chemical: These products can melt in a fire. Molten material may flow or drip and spread the fire.

Hazardous Combustion Products: Combustion may produce toxic and irritating gases and vapors.

Special Protective Equipment and Precautions for Fire-fighters: None required.

6. ACCIDENTAL RELEASE MEASURES

Personal Precautions, Protective Equipment, and Emergency Procedures: None required.

Environmental Precautions: None required.

Methods and Materials for Containment and Cleaning Up: No special precautions required. Pick up and dispose of in an appropriate container.

7. HANDLING AND STORAGE

Precautions for Safe Handling: No special handling is required.

Conditions for Safe Storage, including any Incompatibilities: Store away from heat and flames.

8. EXPOSURE CONTROLS / PERSONAL PROTECTION**Exposure limit(s)**

Chemical Name	Exposure limit(s)
Non-Hazardous Ingredients	None established

Appropriate Engineering Controls: None required.

Individual Protection Measures, such as Personal Protective Equipment:

Respiratory Protection: None required.

Protective Gloves: None required.

Eye Protection: None required.

9. PHYSICAL AND CHEMICAL PROPERTIES

Appearance and Odor	Solid Gloves, blue or white
Odor Threshold:	Not applicable
Boiling point/range	Not applicable
Melting point/range	Not determined
Relative Density (water=1)	Not determined
Vapor pressure	Not applicable
Vapor density (air=1)	Not applicable
Solubility	Insoluble
pH	Not applicable
Partition coefficient (n-octanol/water):	Not applicable
Evaporation Rate (Butyl acetate=1)	Not applicable
Viscosity:	Not applicable
Volatile Organic Carbon Compounds (VOC) (g/L)	Not applicable
Flashpoint:	None.
Flammable Limits in Air % by Volume:	LEL (Lower):Not applicable UEL (Upper): Not applicable
Autoignition temperature:	Not determined.
Decomposition temperature:	Not determined
Flammability (solid, gas):	Not a flammable solid

10. STABILITY AND REACTIVITY

Reactivity: Not reactive.

Chemical Stability: Stable at ambient temperature and pressure.

Possibility of Hazardous Reactions: None known.

Conditions to Avoid: Avoid heat and flames.

Incompatible Materials: None known.

Hazardous Decomposition Products: Thermal decomposition may produce carbon and nitrogen oxides and unidentified hydrocarbon fragments.

**11. TOXICOLOGICAL INFORMATION**

Symptoms/Effects of Overexposure: These gloves are manufactured articles. Their use will not result in exposure to any hazardous materials.

Inhalation: Not applicable.

Skin contact: None. Intended for skin contact. These products contain no natural latex. **Eye contact:** None expected.

Ingestion: Not applicable.

Chronic toxicity: None expected.

Carcinogenicity Data: None of the components of this product is listed as a carcinogen by IARC, NTP, US OSHA or the EU CLP Annex VI.

Reproductive Toxicity: None known.

Numerical Measures of Toxicity:
Not acutely toxic.

12. ECOLOGICAL INFORMATION

Ecotoxicity: These gloves are manufactured articles. Their use will not result in adverse environmental effects.

Persistence and Degradability: Not degradable.

Bioaccumulative Potential: Not bioaccumulative.

Mobility in Soil: Not mobile.

Other Adverse Effects: None currently known.

13. DISPOSAL CONSIDERATIONS

Dispose in accordance with all state, local and federal regulations. If unused, the product may be disposed of as a non-hazardous material.

14. TRANSPORT INFORMATION

US DOT Shipping Description: Not regulated

IATA Shipping Description (Air): Not regulated

IMDG Shipping Description (Vessel): Not regulated

15. REGULATORY INFORMATION**US Regulations**

EPA Toxic Substances Control Act (TSCA): These gloves are articles and exempt from the TSCA regulations.



SAFETY DATA SHEET

HALYARD* PUREZERO* HG3 Nitrile Gloves

SARA 302 Listed Chemicals: None.

SARA 311/312 Hazard Categories: Not applicable to articles

SARA 313 This Product Contains the Following Chemicals Subject to Annual Release Reporting Requirements Under the SARA Section 313 (40 CFR 372):

Not applicable to articles.

16. OTHER INFORMATION

Date Prepared: 6/24/2021

HMIS Rating: Health 0 Fire 1 Physical Hazard 0

The information contained herein is true and correct to the best of O&M Halyard, Inc's knowledge. However, no warranty, expressed or implied, is made. Nothing herein should be interpreted as a recommendation to infringe existing patents or violate any laws or regulations. Final determination of the suitability of the material is the sole responsibility of the user.



July 11, 2023

RE: HALYARD* PUREZERO* HG3 and HG5 Cleanroom Nitrile Gloves

O&M Halyard, Inc. confirms that our Halyard PUREZERO* HG3 and Halyard PUREZERO HG5 Nitrile Cleanroom Glove families are fully compliant with the related requirements of the European Union Regulation (EC) 1907/2006 concerning Registration, Evaluation, Authorization, and Restriction of Chemicals (REACH).

O&M Halyard, Inc. hereby confirms that our Halyard PUREZERO* HG3 and Halyard PUREZERO HG5 Nitrile Cleanroom Gloves either do not contain the presence of greater than 0.1% of substances identified on the SVHC Candidate list according to Article 33 of the REACH Regulation and/or do not contain any of the listed substances.

Thank you for your interest in Halyard products. If you have any questions or need additional information, please do not hesitate to contact us at PIQ@hyh.com or call us directly at (844) 425-9273.

Sincerely,

Caitlin Senter
Director
Global Regulatory Affairs
O&M Halyard, Inc.

*Registered Trademark or Trademark of O&M Halyard or its affiliates. ©2023. All rights reserved. COPY-04686



Certificate of Registration

QUALITY MANAGEMENT SYSTEM - ISO 9001:2015

This is to certify that:

Safeskin Medical & Scientific
(Thailand) Ltd.
200 Moo 8, Kanchanavanich Road,
Tambol Prik, Amphur Sadao,
Songkhla
90120
Thailand

Holds Certificate Number:

FM 697757

and operates a Quality Management System which complies with the requirements of ISO 9001:2015 for the following scope:

Design and Development, Production and Distribution of Industrial Gloves-Sterile and Non-Sterile Examination Gloves.

For and on behalf of BSI:

Michael Lam - Managing Director Assurance, APAC

Original Registration Date: 2018-08-12

Latest Revision Date: 2022-09-01

Effective Date: 2022-09-01

Expiry Date: 2025-08-31

Page: 1 of 2



...making excellence a habit.™

This certificate was issued electronically and remains the property of BSI and is bound by the conditions of contract.

An electronic certificate can be authenticated [online](#).

Printed copies can be validated at www.bsi-global.com/ClientDirectory or telephone +66(2) 2944889-92.

Further clarifications regarding the scope of this certificate and the applicability of ISO 9001:2015 requirements may be obtained by consulting the organization.

This certificate is valid only if provided original copies are in complete set.

ISO 9001:2015 (continued)

Certificate No: **FM 697757**

Location

Safeskin Medical & Scientific
(Thailand) Ltd.
200 Moo 8, Kanchanavanich Road,
Tambol Prik, Amphur Sadao,
Songkhla
90120
Thailand

Registered Activities

Design and Development, Production and Distribution of
Industrial Gloves-Sterile and Non-Sterile Examination Gloves.

Including the following support function:
Owens & Minor Halyard Incorporation. 5405 Windward
Parkway, Alpharetta, GA, USA : Design and Development of
Industrial Gloves-Sterile and Non-Sterile Examination Gloves.



Original Registration Date: 2018-08-12

Latest Revision Date: 2022-09-01

Effective Date: 2022-09-01

Expiry Date: 2025-08-31

Page: 2 of 2

This certificate was issued electronically and remains the property of BSI and is bound by the conditions of contract.

An electronic certificate can be authenticated [online](#).

Printed copies can be validated at www.bsi-global.com/ClientDirectory or telephone +66(2) 2944889-92.

Further clarifications regarding the scope of this certificate and the applicability of ISO 9001:2015 requirements may be obtained by consulting the organization. This certificate is valid only if provided original copies are in complete set.

Information and Contact: BSI, Kitemark Court, Davy Avenue, Knowlhill, Milton Keynes MK5 8PP. Tel: + 44 345 080 9000
BSI Assurance UK Limited, registered in England under number 7805321 at 389 Chiswick High Road, London W4 4AL, UK.
A Member of the BSI Group of Companies.



By Royal Charter

Certificate of Registration

QUALITY MANAGEMENT SYSTEM - ISO 13485:2016 & EN ISO 13485:2016

This is to certify that:

O & M Halyard, Inc.
9120 Lockwood Blvd
Mechanicsville
Virginia
23116
USA

Holds Certificate Number:

MD 735497

and operates a Quality Management System which complies with the requirements of ISO 13485:2016 & EN ISO 13485:2016 for the following scope:

Design, development, manufacture and distribution of sterile and non-sterile medical examination gloves.

For and on behalf of BSI:

Graeme Tunbridge, Senior Vice President Medical Devices

Original Registration Date: 2020-11-25

Latest Revision Date: 2023-01-05

Effective Date: 2023-01-09

Expiry Date: 2026-01-08



Page: 1 of 2

...making excellence a habit.™

ISO 13485:2016 (continued)

Certificate No: **MD 735497**

Location	Registered Activities
O & M Halyard, Inc. 9120 Lockwood Blvd Mechanicsville Virginia 23116 USA	Headquarter management activities.
O & M Halyard, Inc. 1 Edison Drive Alpharetta Georgia 30005 USA	The design and development of sterile and non-sterile medical examination gloves.
Safeskin Medical & Scientific (Thailand) Ltd. 200 Moo 8, Kanchanavanich Road, Tambol Prik, Amphur Sadao, Songkhla 90120 Thailand	Design, development, manufacture and distribution of sterile and non-sterile medical examination gloves.



Original Registration Date: 2020-11-25

Latest Revision Date: 2023-01-05

Effective Date: 2023-01-09

Expiry Date: 2026-01-08

Page: 2 of 2

This certificate was issued electronically and remains the property of BSI and is bound by the conditions of contract.
An electronic certificate can be authenticated [online](#)



Certificate of Registration

ENVIRONMENTAL MANAGEMENT SYSTEM - ISO 14001:2015

This is to certify that:

Safeskin Medical & Scientific
(Thailand) Ltd.
200 Moo 8, Kanchanavanich Road,
Tambol Prik, Amphur Sadao,
Songkhla
90120
Thailand

Holds Certificate Number:

EMS 772160

and operates an Environmental Management System which complies with the requirements of ISO 14001:2015 for the following scope:

The Manufacturing of Medical and Scientific Gloves.

For and on behalf of BSI:

Michael Lam - Managing Director Assurance, APAC

Original Registration Date: 2022-10-27

Effective Date: 2022-10-27

Latest Revision Date: 2022-10-27

Expiry Date: 2025-10-26

Page: 1 of 1



...making excellence a habit.™

This certificate was issued electronically and remains the property of BSI and is bound by the conditions of contract.

An electronic certificate can be authenticated [online](#).

Printed copies can be validated at www.bsi-global.com/ClientDirectory or telephone +66(2) 2944889-92.

Further clarifications regarding the scope of this certificate and the applicability of ISO 14001:2015 requirements may be obtained by consulting the organization.

This certificate is valid only if provided original copies are in complete set.

Information and Contact: BSI, Kitemark Court, Davy Avenue, Knowlhill, Milton Keynes MK5 8PP. Tel: + 44 345 080 9000
BSI Assurance UK Limited, registered in England under number 7805321 at 389 Chiswick High Road, London W4 4AL, UK.
A Member of the BSI Group of Companies.



May 4, 2023

RE: HALYARD* PUREZERO* HG3 and HG5 Nitrile Gloves

Dear Valued Customer,

This letter is in response to your recent accelerator-free inquiry for the HALYARD* PUREZERO* HG3 and HG5 Nitrile Gloves.

The following gloves are accelerator-free and are not formulated with the following vulcanizing chemicals and accelerators: Sulfur, Thiurams, Thioxoles, Guanidines, Carbamates.†

HALYARD* PUREZERO* HG3 White Nitrile Gloves
HALYARD* PUREZERO* HG3 Light Blue Nitrile Gloves
HALYARD* PUREZERO* HG3 White SGX* Nitrile Gloves
HALYARD* PUREZERO* HG3 White Sterile Nitrile Gloves
HALYARD* PUREZERO* HG3 Light Blue Sterile Nitrile Gloves

HALYARD* PUREZERO* HG5 White Nitrile Gloves
HALYARD* PUREZERO* HG5 Blue SGX* Nitrile Gloves

Thank you for your interest in Halyard products. If you have any questions or need additional information, please do not hesitate to contact us at PIQ@hyh.com or call us directly at (844) 425-9273.

Sincerely,

Shannon Smith

Shannon Smith
Associate Product Manager
O&M Halyard, Inc.

† The chemicals and accelerators shown is not a comprehensive list.

*Registered Trademark or Trademark of O&M Halyard or its affiliates.

COPY-04632

ADDED PROTECTION FROM THE RISK OF CHEMICAL EXPOSURE

It's critical to protect staff from exposure to potentially hazardous chemicals and chemotherapy drugs. In addition to providing a barrier to chemical splash, microorganisms and viruses, **PUREZERO*** HG3 Cleanroom Gloves are **now tested against 29 chemicals, 14 chemotherapy drugs and Fentanyl.**

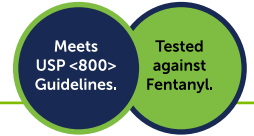

CHEMOTHERAPY DRUG RESISTANCE GUIDE⁴

Chemotherapy Agent (Concentration in mg/ml)	HALYARD* PUREZERO* HG3 Light Blue Sterile Nitrile Gloves	
	Minimum Breakthrough Detection Time (minutes)	Average Steady State Perm. Rate (µg/cm ² /min)
Carmustine (BCNU) (3.3)	44.6	0.21
Cisplatin (1.0)	>240	N/A
Cyclophosphamide (20.0)	>240	N/A
Dacarbazine (10.0)	>240	N/A
Doxorubicin HCL (2.0)	>240	N/A
Etoposide (20.0)	>240	N/A
Fluorouracil (50.0)	>240	N/A
Ifosfamide (50.0)	>240	N/A
Methotrexate (25.0)	>240	N/A
Mitomycin C (0.5)	>240	N/A
Mitoxantrone (2.0)	>240	N/A
Paclitaxel (6.0)	>240	N/A
Thiotepa (10.0)	129.2	0.03
Vincristine (1.0)	>240	N/A
Additional Tests		
Fentanyl Citrate Injection, 100 mcg/2mL	<240	N/A

Use the rating system below to determine the chemotherapy compatibility for exposure:

<10	Not recommended for use - breakthrough can occur in less than 10 minutes.
11 - 239	Use with caution - breakthrough can occur between 11 and 239 minutes.
>240	Recommended for protection - no breakthrough up to 240 minutes.
N/A	The chemotherapy drug did not reach the minimum permeation rate (0.01 µg/cm ² /min) as defined within ASTM D6978.

CAUTION: It's the user's responsibility to determine the applicability of these gloves for their intended use with chemotherapy drugs.

DEFINITION OF TERMS

Breakthrough time: The time required for the test chemical to be detected on the inside of the glove. Essentially, this is the amount of time that the glove can resist a chemical when the glove is fully immersed in the chemical.

Permeation: The process where chemicals, such as liquids, gases and vapors can pass through a glove film (or other PPE interfaces) without penetrating directly through a pinhole, tear or other visible opening.

Permeation rate: The flowrate of the chemical after the chemical breaks through the inside of the glove. It is measured in amount per surface area of the glove per time (µg/cm²/min).

HG3 Nitrile Cleanroom Gloves

CHEMICAL RESISTANCE GUIDE⁵

Chemical (Concentration %)	HALYARD* PUREZERO HG3 Light Blue Nitrile Gloves	
	Minimum Breakthrough Time (minutes)	Permeation Rate (µg/cm ² /min)
1-Butanol (99)	80.7	1.8
Acetic Acid (30)	>480	<1.0
Acrylamide (40)	>480	<1.0
Benzalkonium Chloride (1)	>480	<1.0
Chloroform (70)	0	N/A
Citric Acid (30)	>480	<1.0
Citric Acid (70)	>480	<1.0
Cyclohexane (99)	>480	<1.0
Didecyldimethylammonium Chloride (0.04)	>480	<1.0
Dimethylformamide (99)	0	N/A
Dimethyl Sulfoxide (99)	5.0	3.2
Ethanol (70)	18.6	1.4E+01
Ethanol (99)	8.8	8.8E+01
Ethidium Bromide (1)	>480	<1.0
Formaldehyde (37)	>480	<1.0
Glycolic Acid (10)	>480	<1.0
Glutaraldehyde (50)	>480	<1.0
Heptane (99)	66.6	N/A
Hydrazine Monohydrate (55)	>480	<1.0
Hydrochloric Acid (30)	>480	2.1
Hydrogen Peroxide (6)	>480	<1.0
Hydrogen Peroxide (30)	27.7	1.8
Isopropyl Alcohol (70)	155.3	2.1
Isopropyl Alcohol (99)	87.0	5.4
Methanol (99)	0	N/A
Nitric Acid (65)	11.7	1.6E+03
Peracetic Acid (5)	>480	<1.0
Phosphoric Acid (70)	>480	<1.0
Sodium Hydroxide (50)	>480	<1.0
Sodium Hypochlorite (10-13%)	>480	<1.0
Spor-Klenz (N/A)	>480	<1.0
Sulfuric Acid (50)	>480	<1.0
Sulfuric Acid (99)	10.8	N/A

Use the rating system below to determine the chemical compatibility for exposure:

<10	Not recommended for use - breakthrough can occur in less than 10 minutes.
11 - 479	Use with caution - breakthrough can occur between 11 and 479 minutes.
>480	Permeation breakthrough is excellent. Permeation does not occur during the test (8 hours).
N/A	The chemical did not reach the minimum permeation rate (1 µg/cm ² /min) as defined within EN 16523-1. There is a possibility for trace amounts of the chemical to permeate through the glove.
—	The permeation rate was beyond the range of the detection instruments. The permeation of the chemical through the glove film may be too high for the detector to reach a steady-state reading.

CAUTION: It's the user's responsibility to determine the applicability of these gloves for their intended use.



November 13th, 2023

RE: ESD Testing for HALYARD* PUREZERO* Nitrile Gloves

Dear Valued Customer,

This letter is in response to your recent inquiry regarding ESD testing of HALYARD* PUREZERO* Nitrile Gloves.

The following HALYARD* PUREZERO* Nitrile Glove families have been tested against ANSI/ESD STM15.1:2019 “In-Use Resistance Testing of Gloves and Finger Cots”:

HALYARD* PUREZERO* HG3 Cleanroom Nitrile Gloves

HALYARD* PUREZERO* HG3 White Nitrile Gloves	CLN3031XS
HALYARD* PUREZERO* HG3 White Nitrile Gloves	CLN3031SM
HALYARD* PUREZERO* HG3 White Nitrile Gloves	CLN3031MD
HALYARD* PUREZERO* HG3 White Nitrile Gloves	CLN3031LG
HALYARD* PUREZERO* HG3 White Nitrile Gloves	CLN3031XL
HALYARD* PUREZERO* HG3 Blue Nitrile Gloves	CLN9031XS
HALYARD* PUREZERO* HG3 Blue Nitrile Gloves	CLN9031SM
HALYARD* PUREZERO* HG3 Blue Nitrile Gloves	CLN9031MD
HALYARD* PUREZERO* HG3 Blue Nitrile Gloves	CLN9031LG
HALYARD* PUREZERO* HG3 Blue Nitrile Gloves	CLN9031XL
HALYARD* PUREZERO* HG3 White SGX* Nitrile Gloves	CLN3231XS
HALYARD* PUREZERO* HG3 White SGX* Nitrile Gloves	CLN3231SM
HALYARD* PUREZERO* HG3 White SGX* Nitrile Gloves	CLN3231MD
HALYARD* PUREZERO* HG3 White SGX* Nitrile Gloves	CLN3231LG
HALYARD* PUREZERO* HG3 White SGX* Nitrile Gloves	CLN3231XL
HALYARD* PUREZERO* HG3 White Sterile Nitrile Gloves	CLN323260
HALYARD* PUREZERO* HG3 White Sterile Nitrile Gloves	CLN323265
HALYARD* PUREZERO* HG3 White Sterile Nitrile Gloves	CLN323270
HALYARD* PUREZERO* HG3 White Sterile Nitrile Gloves	CLN323275
HALYARD* PUREZERO* HG3 White Sterile Nitrile Gloves	CLN323280
HALYARD* PUREZERO* HG3 White Sterile Nitrile Gloves	CLN323285
HALYARD* PUREZERO* HG3 White Sterile Nitrile Gloves	CLN323290
HALYARD* PUREZERO* HG3 White Sterile Nitrile Gloves	CLN323210



HALYARD* PUREZERO* HG3 Blue Sterile Nitrile Gloves	CLN923260
HALYARD* PUREZERO* HG3 Blue Sterile Nitrile Gloves	CLN923265
HALYARD* PUREZERO* HG3 Blue Sterile Nitrile Gloves	CLN923270
HALYARD* PUREZERO* HG3 Blue Sterile Nitrile Gloves	CLN923275
HALYARD* PUREZERO* HG3 Blue Sterile Nitrile Gloves	CLN923280
HALYARD* PUREZERO* HG3 Blue Sterile Nitrile Gloves	CLN923285
HALYARD* PUREZERO* HG3 Blue Sterile Nitrile Gloves	CLN923290
HALYARD* PUREZERO* HG3 Blue Sterile Nitrile Gloves	CLN923210

HALYARD* **PUREZERO* HG5 Cleanroom Nitrile Gloves**

HALYARD* PUREZERO* HG5 White Nitrile Gloves	CLN30512XS
HALYARD* PUREZERO* HG5 White Nitrile Gloves	CLN30512SM
HALYARD* PUREZERO* HG5 White Nitrile Gloves	CLN30512MD
HALYARD* PUREZERO* HG5 White Nitrile Gloves	CLN30512LG
HALYARD* PUREZERO* HG5 White Nitrile Gloves	CLN30512XL
HALYARD* PUREZERO* HG5 Blue SGX* Nitrile Gloves	CLN92512XS
HALYARD* PUREZERO* HG5 Blue SGX* Nitrile Gloves	CLN92512SM
HALYARD* PUREZERO* HG5 Blue SGX* Nitrile Gloves	CLN92512MD
HALYARD* PUREZERO* HG5 Blue SGX* Nitrile Gloves	CLN92512LG
HALYARD* PUREZERO* HG5 Blue SGX* Nitrile Gloves	CLN92512XL

HALYARD* **PUREZERO* Nitrile Exam Gloves**

HALYARD* PUREZERO* MARIN* Nitrile Exam Gloves	LFS111XS
HALYARD* PUREZERO* MARIN* Nitrile Exam Gloves	LFS111SM
HALYARD* PUREZERO* MARIN* Nitrile Exam Gloves	LFS111MD
HALYARD* PUREZERO* MARIN* Nitrile Exam Gloves	LFS111LG
HALYARD* PUREZERO* MARIN* Nitrile Exam Gloves	LFS111XL
HALYARD* PUREZERO* MARIN-XTRA* Nitrile Exam Gloves	LFS121XS
HALYARD* PUREZERO* MARIN-XTRA* Nitrile Exam Gloves	LFS121SM
HALYARD* PUREZERO* MARIN-XTRA* Nitrile Exam Gloves	LFS121MD
HALYARD* PUREZERO* MARIN-XTRA* Nitrile Exam Gloves	LFS121LG
HALYARD* PUREZERO* MARIN-XTRA* Nitrile Exam Gloves	LFS121XL
HALYARD* PUREZERO* LIMON* Nitrile Exam Gloves	LFS311XS
HALYARD* PUREZERO* LIMON* Nitrile Exam Gloves	LFS311SM
HALYARD* PUREZERO* LIMON* Nitrile Exam Gloves	LFS311MD



HALYARD* PUREZERO* LIMON* Nitrile Exam Gloves	LFS311LG
HALYARD* PUREZERO* LIMON* Nitrile Exam Gloves	LFS311XL
HALYARD* PUREZERO* LIMON-XTRA* Nitrile Exam Gloves	LFS321XS
HALYARD* PUREZERO* LIMON-XTRA* Nitrile Exam Gloves	LFS321SM
HALYARD* PUREZERO* LIMON-XTRA* Nitrile Exam Gloves	LFS321MD
HALYARD* PUREZERO* LIMON-XTRA* Nitrile Exam Gloves	LFS321LG
HALYARD* PUREZERO* LIMON-XTRA* Nitrile Exam Gloves	LFS321XL
HALYARD* PUREZERO* ULTRA VIOLET* Nitrile Exam Gloves	LFS511XS
HALYARD* PUREZERO* ULTRA VIOLET* Nitrile Exam Gloves	LFS511SM
HALYARD* PUREZERO* ULTRA VIOLET* Nitrile Exam Gloves	LFS511MD
HALYARD* PUREZERO* ULTRA VIOLET* Nitrile Exam Gloves	LFS511LG
HALYARD* PUREZERO* ULTRA VIOLET* Nitrile Exam Gloves	LFS511XL

HALYARD* **PUREZERO* Nitrile Gloves**

HALYARD* PUREZERO* MARIN* Nitrile Gloves	LFS1117XS
HALYARD* PUREZERO* MARIN* Nitrile Gloves	LFS1117SM
HALYARD* PUREZERO* MARIN* Nitrile Gloves	LFS1117MD
HALYARD* PUREZERO* MARIN* Nitrile Gloves	LFS1117LG
HALYARD* PUREZERO* MARIN* Nitrile Gloves	LFS1117XL
HALYARD* PUREZERO* LIMON* Nitrile Gloves	LFS3117XS
HALYARD* PUREZERO* LIMON* Nitrile Gloves	LFS3117SM
HALYARD* PUREZERO* LIMON* Nitrile Gloves	LFS3117MD
HALYARD* PUREZERO* LIMON* Nitrile Gloves	LFS3117LG
HALYARD* PUREZERO* LIMON* Nitrile Gloves	LFS3117XL
HALYARD* PUREZERO* ULTRA VIOLET* Nitrile Gloves	LFS5117XS
HALYARD* PUREZERO* ULTRA VIOLET* Nitrile Gloves	LFS5117SM
HALYARD* PUREZERO* ULTRA VIOLET* Nitrile Gloves	LFS5117MD
HALYARD* PUREZERO* ULTRA VIOLET* Nitrile Gloves	LFS5117LG
HALYARD* PUREZERO* ULTRA VIOLET* Nitrile Gloves	LFS5117XL

Based on the ANSI/ESD STM15.1:2019 test results from an external laboratory at conditions of 12% RH and 23°C, all **HALYARD* **PUREZERO*** Nitrile Glove** product families listed above are within the dissipative classification range (Resistance = 10⁴ to 10¹¹ ohms) as defined by ANSI/ESD standards.

Therefore, **HALYARD* **PUREZERO*** Nitrile Gloves** are considered to be static dissipative in-use. Please note that this is based on a standardized test method in a laboratory environment, and the resistance test results and classification do not fully characterize the glove for all electrostatic properties. Other electrostatic properties, such as charge accumulation, and specific process conditions may need to be assessed based on your particular application prior to use.



Thank you for your interest in Halyard products. If you have any questions or need additional information, please do not hesitate to contact us at PIQ@hyh.com or call us directly at (844) 425-9273.

Sincerely,

A handwritten signature in black ink that reads 'Caitlin Senter'.

Caitlin Senter
Director
Global Regulatory Affairs
O&M Halyard, Inc.

A handwritten signature in black ink that reads 'Ryan Solan'.

Ryan Solan
Manager
Global Research and Development
O&M Halyard, Inc.

*Registered Trademark or Trademark of O&M Halyard or its affiliates. ©2023. All rights reserved.

COPY-04825



RE: Compliance statement – HALYARD* **PUREZERO*** Nitrile Gloves

Please be advised that to the best of O&M Halyard knowledge, the **PUREZERO*** HG3 Nitrile Gloves and HALYARD* **PUREZERO*** HG5 Nitrile Gloves are produced entirely from materials of synthetic origin and therefore are free from human or any other animal derived materials including bovine products (Bovine Spongiform Encephalopathy (BSE) and Transmissible Spongiform Encephalopathy (TSE)).

- *Under various environmental protection and product safety regulations, directives, standards, and initiatives “intentionally introduced” means “deliberately utilized during the manufacture of the components and/or for the formulation of a material or component where its continued presence is desired in the final product to provide a specific property, appearance or quality.”*

This information is based on O&M Halyard, Inc.'s knowledge of these products at the time of publication.

If you have any questions or need additional information, please do not hesitate to contact us at PIQ@hyh.com or call us directly at (844) 425-9273.

–This statement is valid unsigned –

*Registered Trademark or Trademark of O&M Halyard or its affiliates. ©2020, 2022. All rights reserved.



March 14th, 2023

RE: HALYARD* PUREZERO* Nitrile Gloves

Dear Valued Customer,

This letter is in response to your recent inquiry regarding storage conditions of HALYARD* PUREZERO* Nitrile Gloves.

As displayed by the indications on the packaging labeling, HALYARD* PUREZERO* Nitrile Gloves shall be stored in conditions where the product is kept dry (away from moisture), away from direct sunlight, away from sources of heat, and away from radioactive sources. To reduce the potential of accelerated aging, it is recommended to store the product at standard room temperature conditions, when possible.

Thank you for your interest in HALYARD* products. If you have any questions or need additional information, please do not hesitate to contact us at PIQ@hyh.com or call us directly at (844) 425-9273.

Sincerely,

Ryan Solan
R&D Senior Engineer
Global Research and Development
O&M Halyard, Inc.

Theresa McCoy
Global Product Manager
Global Strategic Marketing
O&M Halyard, Inc.

*Registered Trademark or Trademark of O&M Halyard or its affiliates.

COPY-04606



September 24, 2023

RE: HALYARD* PUREZERO* HG3 and HG5 Nitrile Gloves

Dear Valued Customer,

This letter is in response to your recent inquiry regarding the presence of silicone for the PUREZERO* HG3 White Nitrile Gloves, PUREZERO* HG3 White SGX* Nitrile Gloves, PUREZERO* HG3 Light Blue Nitrile Gloves, PUREZERO* HG3 Sterile Light Blue Nitrile Gloves, PUREZERO* HG3 Sterile White Nitrile Gloves, HALYARD* PUREZERO* HG5 White Nitrile Gloves, and HALYARD* PUREZERO* HG5 Blue SGX* Nitrile Gloves.

According to ASTM E1252 Standard Practice for General Techniques for Obtaining Spectra for Qualitative Analysis, the results below reflect the detectable limits of silicone covering the spectral range from 4000cm⁻¹ to 50cm⁻¹ via FT-IR (Fourier Transform Infrared Anaysis). The results below indicate that the HALYARD* PUREZERO* HG3 NITRILE GLOVES and HALYARD* PUREZERO* HG5 NITRILE GLOVES have no silicone detectable on the outside surface and inside surface of either gloves sampled per 3rd party testing.

The following product codes are applicable: PUREZERO* HG3 White Nitrile Gloves: CLN92512XS, CLN92512SM, CLN92512MD, CLN92512LG, CLN92512XL; PUREZERO* HG3 Light Blue Nitrile Gloves: CLN90511XS, CLN90511SM, CLN90511MD, CLN90511LG, CLN90511XL; PUREZERO* HG3 White SGX* Nitrile Gloves: CLN3031XS, CLN3031SM, CLN3031MD, CLN3031LG, CLN3031XL; PUREZERO* HG3 Sterile White Nitrile Gloves: CLN323260, CLN323265, CLN323270, CLN323275, CLN323280, CLN323290, CLN323210; PUREZERO* HG3 Sterile Light Blue Nitrile Gloves: CLN923260, CLN923265, CLN923270, CLN923275, CLN923280, CLN923285, CLN923290, CLN923210; HALYARD* PUREZERO* HG5 White Nitrile Gloves: CLN30512XS, CLN30512SM, CLN30512MD, CLN30512LG, and CLN30512XL; HALYARD* PUREZERO* HG5 Blue SGX* Nitrile Gloves: CLN92512XS, CLN92512SM, CLN92512MD, CLN92512LG, and CLN92512XL.

Fourier Transform Per ASTM Infrared Anaysis (FT-IR) E1252-98(21)	
Gloves	Results
PUREZERO* HG3 and HG5 Nitrile Gloves	No silicon detected

Thank you for your interest in Halyard products. If you have any questions or need additional information, please do not hesitate to contact us at PIQ@hyh.com or call us directly at (844) 425-9273.

Sincerely

*Registered Trademark or Trademark of O&M Halyard or its affiliates. ©2023. All rights reserved.

COPY-04662



A handwritten signature in black ink that reads 'Caitlin Senter'.

Caitlin Senter
Director
Global Regulatory Affairs
O&M Halyard, Inc.

A handwritten signature in black ink that reads 'Nimia Maya'.

Nimia Maya
R&D Engineer II
Global Research and Development
O&M Halyard, Inc.

TITLE: HALYARD* PUREZERO* HG3 & HG5 Nitrile Gloves Packaging

UPDATE: Alternate packaging supplier for HALYARD* PUREZERO* HG3 and HG5 Nitrile Gloves

WHAT YOU NEED TO KNOW:

There will be an alternate supplier for the packaging (poly bag, poly pouch and poly wallet) used for **HALYARD* PUREZERO* HG3 and HG5 Nitrile Gloves**

WHAT YOU CAN EXPECT:

There is an alternate supplier being qualified to supply the poly bag, poly pouch and poly wallet used to package **HALYARD* PUREZERO* HG3 and HG5 Nitrile Gloves**. The alternate supplier, TAKO Astatic Technology SDN BHD, will supply the same packaging as our current supplier, Tip Corporation SDN BHD. All specifications for the packaging, including the material, composition, dimensions, thickness, and ink, will be identical to the current packaging. There will be no change to the appearance of the packaging or printing. There will be no change to the sterilization process or the sterility assurance level of the products. Additionally, there will be no changes to the product codes or product labeling.

TIMING OF CHANGE: There will be a rolling change for the alternate supplier's packaging that will enter our inventory as early as December 2023. Both packaging vendors could be used based on supply chain availability.



PRODUCTS IMPACTED BY THIS CHANGE:

PUREZERO* HG3 White Nitrile Gloves
CODE
CLN3031XS
CLN3031SM
CLN3031MD
CLN3031LG
CLN3031XL
PUREZERO* HG3 Light Blue Nitrile Gloves
CODE
CLN9031XS
CLN9031SM
CLN9031MD
CLN9031LG
CLN9031MD
PUREZERO* HG3 White SGX* Nitrile Gloves
CODE
CLN3231XS
CLN3231SM
CLN3231MD
CLN3231LG
CLN3231XL
PUREZERO* HG3 White Sterile Nitrile Gloves
CODE
CLN323260
CLN323265
CLN323270
CLN323275
CLN323280
CLN323285
CLN323290
CLN323210
PUREZERO* HG3 Light Blue Sterile Nitrile Gloves
CODE
CLN923260
CLN923265
CLN923270
CLN923275
CLN923280
CLN923285
CLN923290
CLN923210



PUREZERO* HG5 White Nitrile Gloves
CODE
CLN30512XS
CLN30512SM
CLN30512MD
CLN30512LG
CLN30512XL
PUREZERO* HG5 Blue SGX* Nitrile Gloves
CODE
CLN92512XS
CLN92512SM
CLN92512MD
CLN92512LG
CLN92512XL

Thank you for your interest in HALYARD* products. If you have any questions or need additional information including example certifications, please do not hesitate to contact us at PIQ@hyh.com, call us directly at 1-844-425-9273 or reach out to your O&M Halyard commercial representative or distributor.

Sincerely,

Gustavo Fiallos
Director Global Quality Operations, Owens & Minor

*Registered Trademark or Trademark of O&M Halyard. © 2023. All rights reserved. COPY-04748